



HAL
open science

Waveforms MOdels for Machine Type CommuNication inteGrating 5G Networks (WONG5) Document Number D3.3 Overall power budget

Yves Louët, Amor Nafkha, Hmaied Shaiek, Daniel Roviras, Rafik Zayani

► To cite this version:

Yves Louët, Amor Nafkha, Hmaied Shaiek, Daniel Roviras, Rafik Zayani. Waveforms MOdels for Machine Type CommuNication inteGrating 5G Networks (WONG5) Document Number D3.3 Overall power budget. [Research Report] CentraleSupélec; Conservatoire national des arts et métiers - CNAM. 2018. hal-02456416

HAL Id: hal-02456416

<https://hal-cnam.archives-ouvertes.fr/hal-02456416>

Submitted on 4 Feb 2020

HAL is a multi-disciplinary open access archive for the deposit and dissemination of scientific research documents, whether they are published or not. The documents may come from teaching and research institutions in France or abroad, or from public or private research centers.

L'archive ouverte pluridisciplinaire **HAL**, est destinée au dépôt et à la diffusion de documents scientifiques de niveau recherche, publiés ou non, émanant des établissements d'enseignement et de recherche français ou étrangers, des laboratoires publics ou privés.

Waveforms Models for Machine Type CommuNication inteGrating 5G Networks

(WONG5)

Document Number D3.3

Overall power budget

| | |
|--------------------------------------|---|
| Contractual date of delivery: | 12/05/2018 |
| Project Number and Acronym: | ANR-15-CE25-0005, WONG5 |
| Editor: | CentraleSupélec |
| Authors: | Yves LOUET, Amor NAFKHA, Hmaied SHAIK, Daniel ROVIRAS, Rafik ZAYANI |
| Participants: | CS, CNAM |
| Workpackage: | WP3 |
| Security: | PU |
| Nature: | Report |
| Version: | 0.1 |
| Total Number of Pages: | 26 |

Abstract:

This deliverable provides simulation results to establish a realistic power budget of a transmitter by taking into account waveforms PAPR reduction techniques and the high power amplifier (HPA). The waveforms used are the Orthogonal Frequency Division Multiplexing CP-OFDM, weighted overlap and add OFDM (WOLA-OFDM), Block-Filtered OFDM (BF-OFDM), Universal Filtered OFDM (UFMC) and Filtered OFDM (f-OFDM) coupled with a Peak to Average Power Ratio (PAPR) method (SeLected Mapping) so as to increase the HPA efficiency. Simulation results show that there is a clear trade-off between the PAPR reduction gain and the overall power budget of the transmitter and that a PAPR reduction method has to be chosen according with its complexity and the output power of the considered power amplifier.

Keywords : Power amplifier, efficiency, post-OFDM, consumption, power budget

Executive Summary

WONG5 project aims to benchmark post-OFDM waveforms in a Machine Type Communications context for 5G by taking into account the following parameters : resistance to asynchronous users (time and frequency), resistance to time and frequency selectivities, MIMO compatibilities, complexity and power budget. This last issue regards the present deliverable D3.3 entitled "Overall power budget". As it is well known that all post-OFDM waveforms exhibit high peak to average power ratios (PAPRs), the associated signals are amplified with very low efficiency values. One solution to increase this efficiency is to set up a PAPR reduction method (Selected Mapping in this study) to decrease the original PAPR value so as to increase the power amplifier efficiency accordingly. The consequence is an increase of the output power and the transmission range of the signal. Nevertheless the price to pay is the method complexity and its associated consumption which may shadows the benefit of the PAPR reduction methods. Very few works in the literature dwell on this issue that is to estimate the impact of the PAPR reduction complexity on the overall efficiency of the transmitter including the waveforms, the PAPR reduction method and the power amplifier. To do so this deliverable had a two-fold objective :

- to estimate the consumption of the transmitter (waveform + PAPR reduction method) for the following waveforms : CP-OFDM, WOLA-OFDM, f-OFDM, UFMC and BF-OFDM. This has been done with Vivado System Generator which provides the VHDL architecture (related to a targeted FPGA board) and the associated consumption from a high level description of the processing (Matlab codes),
- to estimate the efficiency of the power amplifier by taking into account the consumption deduced from the aforementioned step.

The following conclusions can be drawn :

- the consumption simulations are in accordance with the complexity derivations for all waveforms associated to SLM : the more complex the PAPR reduction method, the more the consumption,
- while integrating the consumption figures in the overall power budget, it is shown that there is a trade-off between the PAPR reduction gain and the efficiency of the power amplifier. For low PAPR reduction gains, the complexity is low what results in a low power efficiency. At the opposite for large PAPR reduction gains, the complexity is large and the efficiency remains low. In between, there is a kind of threshold in the PAPR reduction method which provides the largest efficiency. This has been observed for CP-OFDM, WOLA-OFDM, F-OFDM and BF-OFDM,
- it has to be mentioned that a PAPR reduction method is of potential interest only if its associated power consumption is of same order of magnitude or lower than the output HPA power. For the UFMC waveform, the SLM method is so complex that its power consumption (more than 10W) lowers the efficiency by large what makes this waveform not suitable for a transmitter of about 1W output power.

Table of Contents

| | | |
|----------|---|-----------|
| 1 | Introduction | 4 |
| 2 | System model | 5 |
| 2.1 | Considered waveforms | 5 |
| 2.2 | PAPR reduction method used and its performance | 5 |
| 2.3 | HPA used | 8 |
| 3 | Complexity of SLM method with considered waveforms | 11 |
| 3.1 | WFs complexity analysis | 11 |
| 3.1.1 | CP-OFDM | 11 |
| 3.1.2 | WOLA-OFDM | 11 |
| 3.1.3 | UFMC | 11 |
| 3.1.4 | f-OFDM | 12 |
| 3.1.5 | BF-OFDM | 12 |
| 3.2 | Complexity analysis of the SLM technique | 13 |
| 3.2.1 | CP-OFDM | 13 |
| 3.2.2 | WOLA-OFDM | 14 |
| 3.2.3 | UFMC | 14 |
| 3.2.4 | f-OFDM | 15 |
| 3.2.5 | BF-OFDM | 16 |
| 3.3 | Synthesis on complexity | 17 |
| 4 | Overall power budget evaluation | 18 |
| 4.1 | Objective | 18 |
| 4.2 | Methodology | 18 |
| 4.3 | Simulation results | 19 |
| 4.3.1 | Consumption results of SLM method for all waveforms | 19 |
| 4.3.2 | HPA efficiency with SLM results | 19 |
| 5 | Conclusion | 24 |
| 6 | References | 25 |

1. Introduction

It is well known that any transmission based on multicarrier modulations is prone to high power fluctuations quantified by their peak to average power ratio (PAPR). Many studies and papers have been published for decades on this topic to find methods to mitigate these high PAPR values so as to gain in the high power amplifier (HPA) efficiency [JY08]. It has to be noted that PAPR reduction is one way to increase the HPA efficiency by acting on the signal itself but one can also modify the HPA linearity by changing the architecture what leads to techniques as Envelope Tracking, LINC, Doherty or Envelope Elimination and Restoration or by linearizing the HPA using Digital Predistorsion (DPD) for example.

In this deliverable we consider the Selected Mapping (SLM) [BFH96] as PAPR reduction method applied to five different waveforms : OFDM, WOLA-OFDM, BF-OFDM, UFMC and f-OFDM. The choice of these waveforms is justified by the works done on Machine Type Communication for 5G where post-OFDM waveforms are strong candidates so as to improve the low spectrum efficiency of OFDM [pro17a, pro16, pro17b]. Nevertheless the PAPR problem remains open.

A huge quantity of papers deal with PAPR reduction methods (ie their benefits with regards to their shortcomings), less on their complexities and very few on their real impact on the power amplifier efficiency. This is the originality of this study which has a threefold objective : (i) generation of the VHDL architecture of the SLM method with the waveforms (ii) estimate the associated power consumption (iii) calculation of the HPA efficiency taking into account the power consumption due to the SLM method.

This study shows that the HPA efficiency exhibits a maximum putting in light the trade-off between the PAPR reduction gain and the complexity of the SLM method : before this maximum, the PAPR gain provides a large HPA efficiency versus the SLM complexity and consumption. But after this maximum, even though the PAPR gain is larger, the associated SLM complexity is too large what penalizes the HPA efficiency.

2. System model

2.1 Considered waveforms

The considered waveforms (WF) in this study are : CP-OFDM, WOLA-OFDM, BF-OFDM, f-OFDM and UPMC. These WF have been presented in Deliverable 3.2. The simulation parameters of the selected WFs are gathered in table 2-1.

2.2 PAPR reduction method used and its performance

PAPR reduction is one way to increase the power amplifier efficiency by acting of the envelope of the signal to be amplified and transmitted. This topic has provided a huge amount of publications for decades and many types of methods [LP08, JY08]. The method performed in this study is the Selected Mapping (SLM) published in [BFH96]. The reason is that SLM is a very powerful method and one of the most well known. This method can be updated to have no side information transmission. The idea of SLM is to perform several copies of the initial signal by modifying the phase, amplitude and/or position of subcarriers and then select the copy of minimum PAPR. A block diagram of SLM technique (for OFDM) is shown in Fig. 2-1.

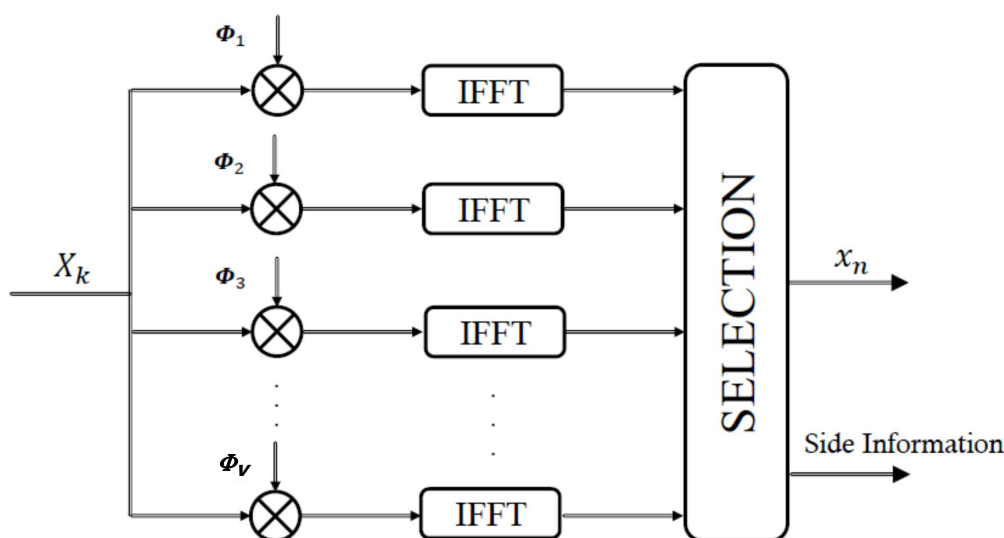

Figure 2-1: Illustration of SLM method for CP-OFDM

In details (for the CP-OFDM) the input data sequences are multiplied by V different phase sequences to generate alternative input symbol sequences. Each of these alternative input data sequences are then applied to IFFT operation, and then the one with the lowest PAPR is selected for transmission. Therefore, its performance in reducing the PAPR directly depends on the number and the design of phase factors. The corresponding selected phase factor also needs to be transmitted to the receiver as side information to properly extract the original information at the receiver side. Its major drawback is the high computational complexity and the loss of bandwidth efficiency, since it needs V IFFT operations and $\log(V)$ as side information.

Table 2-1: WFs simulation parameters

| CP-OFDM | |
|--|--|
| FFT size (N) | 256 |
| CP length (N_{CP}) | 18 |
| WOLA-OFDM | |
| FFT size (N) | 256 |
| CP length (N_{CP}) | 18 |
| Windowing | Raised cosine |
| Window length (W_{Tx}, W_{Rx}) | (5, 5) |
| UFMC (UF-OFDM) | |
| FFT size (N) | 256 |
| Filter | Dolph-Chebyshev |
| Filter length ($L_{FIR} = ZP + 1$) | 19 |
| Zero padding length | 18 |
| Stop-band attenuation | 40 dB |
| Receive windowing | Raised cosine |
| Number of subcarrier/RB (n) | 12 |
| f-OFDM | |
| FFT size (N) | 256 |
| Filter | the same at both Tx and Rx sides see D2.1 [pro16] |
| Filter length (L) | 128 |
| CP length (N_{CP}) | 18 |
| Transition band | $2.5 \times 15 \text{ kHz}$ |
| Burst truncation ($N_{CP}/2$) | on each side |
| BF-OFDM | |
| Number of subcarrier groups (M) | 32 |
| Number of subcarrier per group ($N_{BF}/2$) | 8 |
| Rx FFT size ($MN_{BF}/2$) | 256 |
| Guar Interval, CP size | 4 |
| Transition band | $2.5 \times 15 \text{ kHz}$ |
| Prototype Filter (for Tx filter bank) | Gaussian ($BT = 0.33$) |

In Figs. 2-2 to 2-6, we recall the performance of the SLM algorithm for CP-OFDM, WOLA-OFDM, UFMC, f-OFDM and BF-OFDM. We can conclude from these figures that the performance in terms of PAPR reduction increases with the number of rotation vectors V .

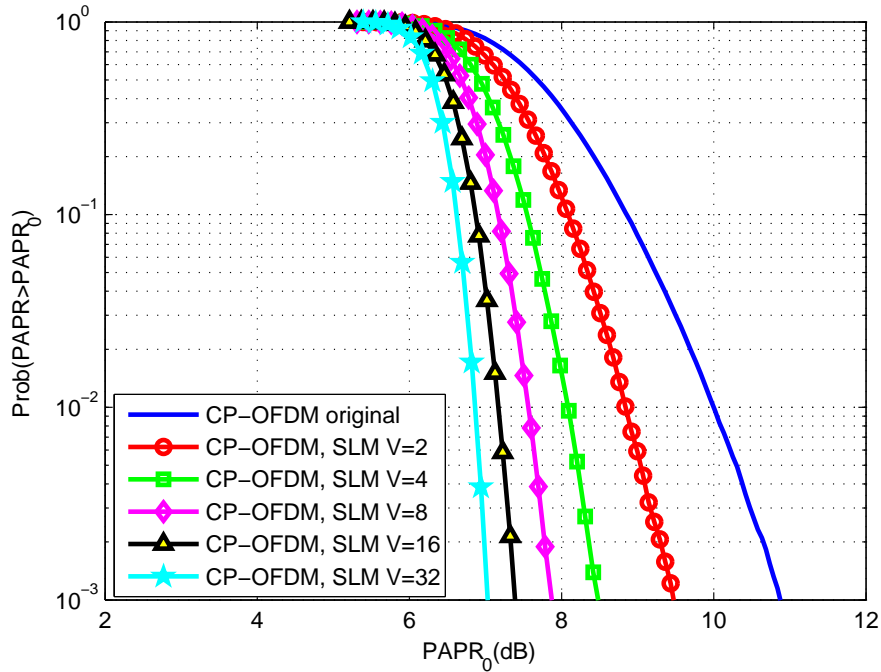

Figure 2-2: CCDF of PAPR for CP-OFDM with SLM technique

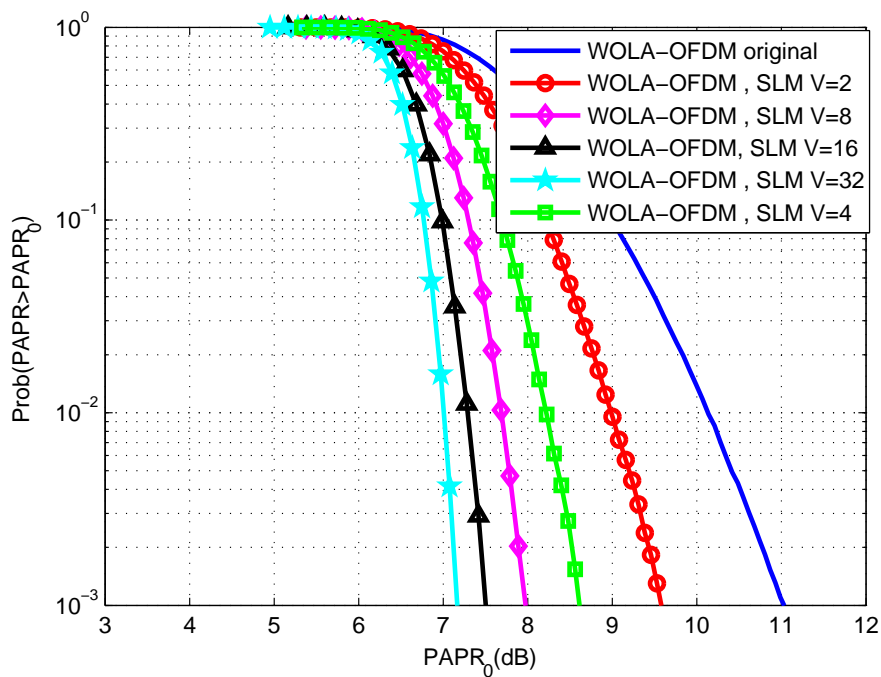

Figure 2-3: CCDF of PAPR for WOLA-OFDM with SLM technique

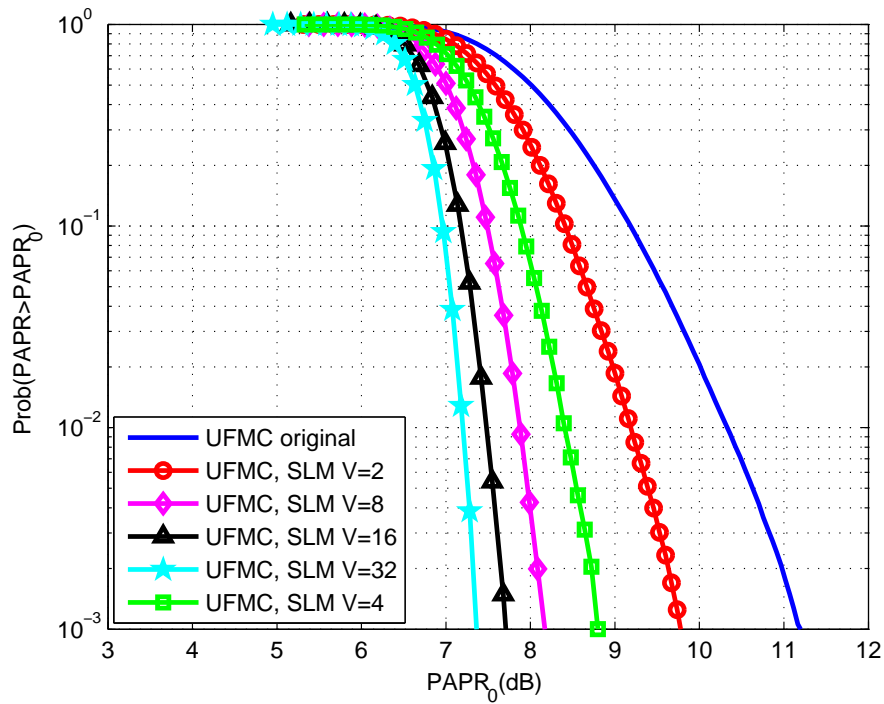

Figure 2-4: CCDF of PAPR for UFMC with SLM technique

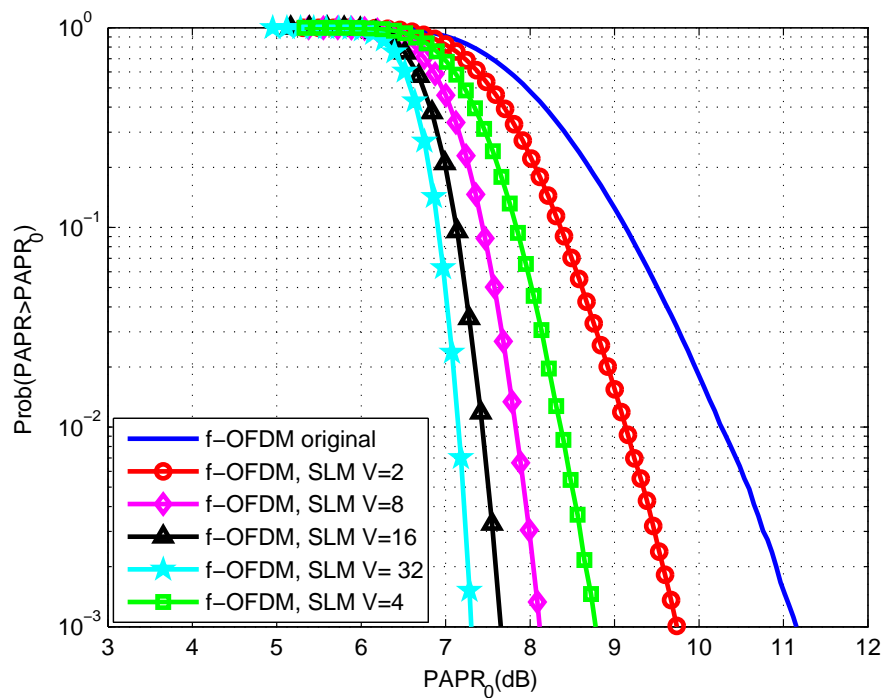

Figure 2-5: CCDF of PAPR for f-OFDM with SLM technique

2.3 HPA used

The HPA used in this study is a typical 4 GHz LTE user equipment power amplifier. The AM/AM and AM/PM conversions characteristics of this HPA are given in Figs. 2-7 and

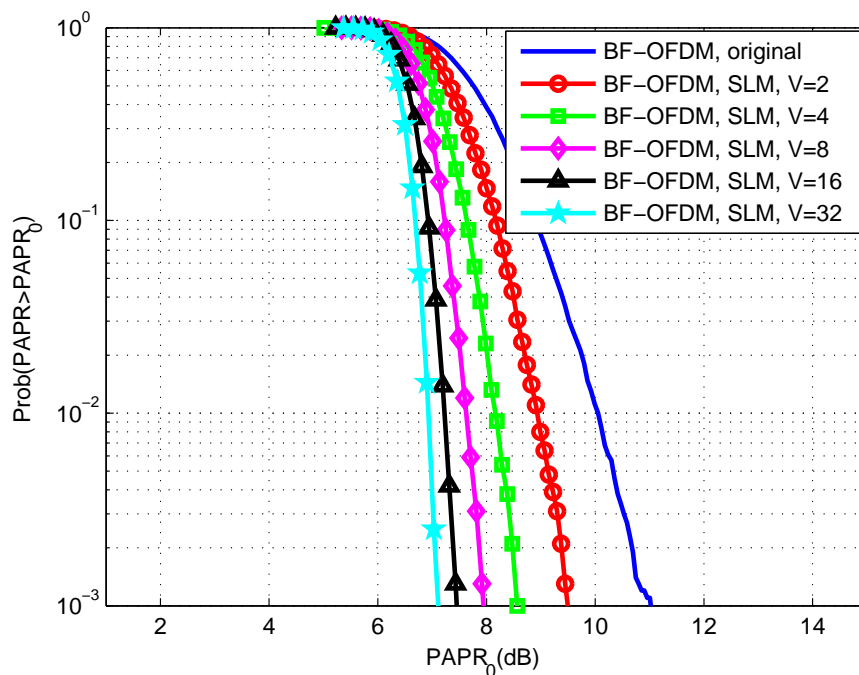

Figure 2-6: CCDF of PAPR for BF-OFDM with SLM technique

2-8 respectively. Fig. 2-9 illustrates the power consumption of the HPA versus the input power.

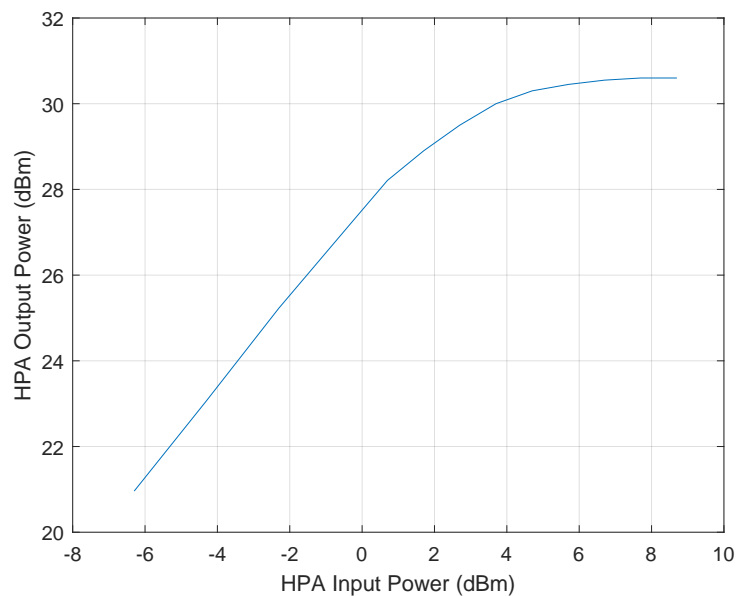

Figure 2-7: AM/AM characteristic of the HPA

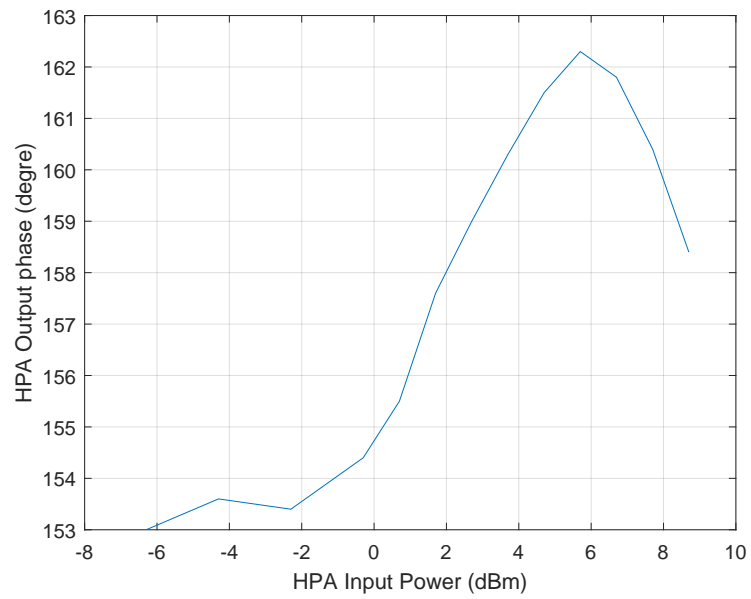

Figure 2-8: AM/PM characteristic of the HPA

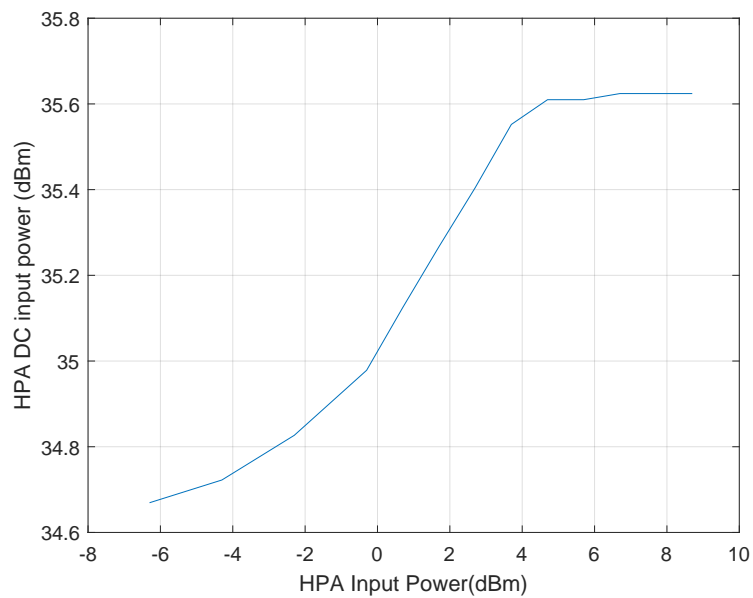

Figure 2-9: Power consumption P_{DC} of the HPA

3. Complexity of SLM method with considered waveforms

3.1 WFs complexity analysis

An exhaustive complexity analysis has been carried in D2.1 [pro16], D2.2 [pro17a] and the IEEE-Access paper [MTG⁺17], for all the WFs studied in WONG5 project. In the following we will remind the complexity of the transmitter and receiver schemes for the considered WFs in D3.3. The complexity will be assessed by counting the number of real multiplications and real additions to perform both the modulation and demodulation process. It should be noted that in D2.1[pro16], D2.2 [pro17a] and in the IEEE Access paper [MTG⁺17], it has been preferred to assess the number of multiplications per unit of time in order to compare as fairly as possible the schemes that do not share the same sampling frequency (case of BF-OFDM).

From now, it will be assumed that one complex multiplication can be carried out with three real multiplications [Kra99]. For the additions, it's straightforward to say that a complex addition requires 2 real additions. Moreover, the Cooley-Tukey implementation will be considered for the Fast Fourier Transforms (FFT).

3.1.1 CP-OFDM

The complexity of the transmitter (resp. the receiver) is reduced to a N-points IFFT (resp. N-points FFT), which leads to:

$$C_{\text{OFDM,Tx/Rx}}^* = \frac{3N}{2} \log_2(N) \quad (3.1)$$

In terms of additions, we have:

$$C_{\text{OFDM,Tx/Rx}}^+ = 2N \log_2(N) \quad (3.2)$$

3.1.2 WOLA-OFDM

When it comes to WOLA-OFDM, the complexity also takes into consideration the windowing (real coefficients applied to complex data).

$$C_{\text{WOLA,Tx}}^* = \frac{3N}{2} \log_2(N) + 4W_{\text{Tx}} \quad (3.3)$$

$$C_{\text{WOLA,Rx}}^* = \frac{3N}{2} \log_2(N) + 4W_{\text{Rx}} \quad (3.4)$$

In terms of additions, we have:

$$C_{\text{WOLA,Tx/Rx}}^+ = 2N \log_2(N) \quad (3.5)$$

3.1.3 UFMC

The data is processed at the RB level (B active RBs out of N available subcarriers). For each RB, first there is the predistortion stage with n complex multiplications. Then there is the transposition to the time domain with only n active sub carriers out of N . The IFFT is therefore mainly fed by null elements and its complexity can be reduced to $N + \frac{N}{2} \log_2(n)$ complex multiplications. The convolution with the baseband real filter

(of length L_{FIR}) adds $N \lfloor \frac{L_{FIR}}{2} \rfloor$ multiplications (neglecting the rise and fall time of the convolution). Finally the up-conversion to the carrier frequencies counts for $(N + L_{FIR} - 1)$ complex multiplications.

At the receiver side, there is a $2N$ -point FFT.

$$C_{\text{UFMC,Tx}}^* = 3B \left(N + \frac{N}{2} \log_2(n) \right) + 3B(N + L_{FIR} - 1) + 2BN \lfloor \frac{L_{FIR}}{2} \rfloor \quad (3.6)$$

$$C_{\text{UFMC,Rx}}^* = 6N \log_2(2N) \quad (3.7)$$

Regarding additions and at the transmitter side, they could be reduced to $2N \log_2(n)$ real additions for the IFFT operation. While, the convolution with the baseband real filter (of length L_{FIR}) adds $2N \lfloor \frac{L_{FIR}}{2} \rfloor$ real multiplications. Then, we have the following number of additions at the transmitter and receiver sides.

$$C_{\text{UFMC,Tx}}^+ = 2BN \log_2(n) + 2BN \lfloor \frac{L_{FIR}}{2} \rfloor \quad (3.8)$$

$$C_{\text{UFMC,Rx}}^+ = 4N \log_2(2N) \quad (3.9)$$

It must be pointed out that reduced complexity schemes have been proposed recently for UFMC [WS15] [JNB18], at the price of a slight performance degradation. These optimized schemes are not considered in this analysis.

3.1.4 f-OFDM

The complexity of this modulation scheme is induced by the FFT and the filtering. The filter shape of length L is real and therefore the filtering operation is followed by a up-conversion adding $2 \times (N_{FFT} + N_{CP} + L - 1)$ extra real multiplications.

$$C_{\text{f-OFDM,Tx/Rx}}^* = \frac{3N}{2} \log_2(N) + 2(N + N_{CP}) \lfloor \frac{L}{2} \rfloor + 2(N + N_{CP} + L - 1) \quad (3.10)$$

where N_{CP} is the CP length and L the filter length.

In terms of additions, we have:

$$C_{\text{f-OFDM,Tx/Rx}}^+ = 2N \log_2(N) + 2(N + N_{CP}) \lfloor \frac{L}{2} \rfloor \quad (3.11)$$

3.1.5 BF-OFDM

For BF-OFDM, at the transmitter side, there is an additional stage with respect to the FFT-FBMC scheme: the predistortion stage. Moreover, the receiver is reduced to a $\frac{MN_{BF}}{2}$ -point FFT.

$$C_{\text{BF-OFDM,Tx}}^* = 3B \frac{N_{BF}}{2} + 3B \frac{N_{BF}}{2} \left(1 + \log_2 \left(\frac{N_{BF}}{2} \right) \right) + 2KM N_{BF} + 3N_{BF} \frac{M}{2} \log_2(M) \quad (3.12)$$

$$C_{\text{BF-OFDM,Rx}}^* = 3 \frac{MN_{\text{BF}}}{4} \log_2\left(\frac{MN_{\text{BF}}}{2}\right) \quad (3.13)$$

In a first approximation, the Tx complexity of BF-OFDM is twice the one of CP-OFDM. We have thus:

$$C_{\text{BF-OFDM,Tx}}^* \sim \frac{3MN_{\text{BF}}}{2} \log_2\left(\frac{MN_{\text{BF}}}{2}\right) \quad (3.14)$$

With this approximation, we have the following Tx complexity, in terms of additions.

$$C_{\text{BF-OFDM,Tx}}^+ \sim 2MN_{\text{BF}} \log_2\left(\frac{MN_{\text{BF}}}{2}\right) \quad (3.15)$$

3.2 Complexity analysis of the SLM technique

3.2.1 CP-OFDM

For each multiplicative vector C^v of the SLM method (V vectors) we have:

1. Multiplication of active subcarriers by vector C^v (complex rotations by $(+1, -1, +j, -j)$):

$$C_{1,\text{CP-OFDM},*}^{\text{SLM}} = 3N \quad (3.16)$$

$$C_{1,\text{CP-OFDM},+}^{\text{SLM}} = 0 \quad (3.17)$$

2. Computation of output CP-OFDM signal in the time domain, which corresponds to the CP-OFDM Tx complexity given by equations 3.23 and 3.24:

$$C_{2,\text{CP-OFDM},*}^{\text{SLM}} = \frac{3N}{2} \log_2(N) \quad (3.18)$$

$$C_{2,\text{CP-OFDM},+}^{\text{SLM}} = 2N \log_2(N) \quad (3.19)$$

3. Computation of PAPR in the time domain signal requires:

$$C_{3,\text{CP-OFDM},*}^{\text{SLM}} = 3N \quad (3.20)$$

$$C_{3,\text{CP-OFDM},+}^{\text{SLM}} = 0 \quad (3.21)$$

The total complexity in terms of real multiplications is then equal to:

$$\begin{aligned} C_{\text{CP-OFDM},*}^{\text{SLM}} &= V(C_{1,\text{CP-OFDM},*}^{\text{SLM}} + C_{2,\text{CP-OFDM},*}^{\text{SLM}} + C_{3,\text{CP-OFDM},*}^{\text{SLM}}) \quad (3.22) \\ &= V\left(6N + \frac{3N}{2} \log_2(N)\right) \end{aligned}$$

In terms of real additions, we have the following additions :

$$\begin{aligned} C_{\text{CP-OFDM},+}^{\text{SLM}} &= V(C_{1,\text{CP-OFDM},+}^{\text{SLM}} + C_{2,\text{CP-OFDM},+}^{\text{SLM}} + C_{3,\text{CP-OFDM},+}^{\text{SLM}}) \quad (3.23) \\ &= 2VN \log_2(N) \end{aligned}$$

3.2.2 WOLA-OFDM

For each multiplicative vector C^v , we achieve:

1. Multiplication of active subcarriers by vector C^v :

$$C_{1,WOLA-OFDM,*}^{SLM} = 3N \quad (3.24)$$

$$C_{1,WOLA-OFDM,+}^{SLM} = 0 \quad (3.25)$$

2. Computation of WOLA-OFDM signal in the time domain:

$$C_{2,WOLA-OFDM,*}^{SLM} = C_{WOLA,Tx}^* = \frac{3N}{2} \log_2(N) + 4W_{Tx} \quad (3.26)$$

where W_{Tx} is the Tx window length.

$$C_{2,WOLA-OFDM,+}^{SLM} = C_{WOLA,Tx/Rx}^+ = 2N \log_2(N) \quad (3.27)$$

3. Computation of PAPR in the time domain signal requires:

$$C_{3,WOLA-OFDM,*}^{SLM} = 3N + 6W_{Tx} \quad (3.28)$$

$$C_{3,WOLA-OFDM,+}^{SLM} = 0 \quad (3.29)$$

The total complexity in terms of real multiplications is then equal to:

$$\begin{aligned} C_{WOLA-OFDM,*}^{SLM} &= V(C_{1,WOLA-OFDM,*}^{SLM} + C_{2,WOLA-OFDM,*}^{SLM} + C_{3,WOLA-OFDM,*}^{SLM}) \quad (3.30) \\ &= V(6N + \frac{3N}{2} \log_2(N) + 10W_{Tx}) \end{aligned}$$

The total complexity in terms of real additions is equal to:

$$\begin{aligned} C_{WOLA-OFDM,+}^{SLM} &= V(C_{1,WOLA-OFDM,+}^{SLM} + C_{2,WOLA-OFDM,+}^{SLM} + C_{3,WOLA-OFDM,+}^{SLM}) \quad (3.31) \\ &= 2NV \log_2(N) \end{aligned}$$

3.2.3 UFMC

For each vector C^v , we have :

1. Multiplication of active subcarriers by vector C^v :

$$C_{1,UFMC,*}^{SLM} = 3N \quad (3.32)$$

$$C_{1,UFMC,+}^{SLM} = 0 \quad (3.33)$$

2. Computation of UFMC signal in the time domain. Based on the results discussed previously, regarding the Tx complexity of this WF, we can write :

$$\begin{aligned} C_{2,UFMC,*}^{SLM} &= C_{UFMC,Tx}^* = 3B \left(N + \frac{N}{2} \log_2(n) \right) \quad (3.34) \\ &\quad + 3B(N + L_{FIR} - 1) + 2BN \left[\frac{L_{FIR}}{2} \right] \end{aligned}$$

In terms of real additions, we have :

$$C_{2,UFMC,+}^{SLM} = C_{UFMC,Tx}^+ = 2BN \log_2(n) + 2BN \left[\frac{L_{FIR}}{2} \right] \quad (3.35)$$

3. Computation of PAPR in the time domain signal requires:

$$C_{3,UFMC,*}^{SLM} = 3(N + L_{FIR} - 1) \quad (3.36)$$

$$C_{3,UFMC,+}^{SLM} = 0 \quad (3.37)$$

The total complexity, in terms of real multiplications, is then equal to:

$$\begin{aligned} C_{UFMC,*}^{SLM} &= V(C_{1,UFMC,*}^{SLM} + C_{2,UFMC,*}^{SLM} + C_{3,UFMC,*}^{SLM}) \\ &= 3B \left(N + \frac{N}{2} \log_2(n) \right) \\ &\quad + 3(B + 1)(N + L_{FIR} - 1) + N(2B \lfloor \frac{L_{FIR}}{2} \rfloor + 3) \end{aligned} \quad (3.38)$$

In terms of real additions, we have the following complexity.

$$\begin{aligned} C_{UFMC,+}^{SLM} &= V(C_{1,UFMC,+,+}^{SLM} + C_{2,UFMC,+,+}^{SLM} + C_{3,UFMC,+,+}^{SLM}) \\ &= 2BVN \log_2(n) + 2BVN \lfloor \frac{L_{FIR}}{2} \rfloor \end{aligned} \quad (3.39)$$

3.2.4 f-OFDM

Each multiplicative vector C^v needs:

1. Multiplication of active subcarriers by vector C^v :

$$C_{1,f-OFDM,*}^{SLM} = 3N \quad (3.40)$$

$$C_{1,f-OFDM,+}^{SLM} = 0 \quad (3.41)$$

2. Computation of f-OFDM signal in the time domain. We can refer to equation (4.8) of deliverable D2.1 [pro16]. This complexity is given by:

$$C_{2,f-OFDM,*}^{SLM} = C_{f-OFDM,Tx/Rx}^* = \frac{3N}{2} \log_2(N) + 2(N + N_{CP}) \lfloor \frac{L}{2} \rfloor + 2(N + N_{CP} + L - 1) \quad (3.42)$$

$$C_{2,f-OFDM,+}^{SLM} = C_{f-OFDM,Tx/Rx}^+ = 2N \log_2(N) + 2(N + N_{CP}) \lfloor \frac{L}{2} \rfloor \quad (3.43)$$

3. Computation of PAPR in the time domain signal requires:

$$C_{3,f-OFDM,*}^{SLM} = 3(N + L - 1) \quad (3.44)$$

$$C_{3,f-OFDM,+}^{SLM} = 0 \quad (3.45)$$

The total complexity in terms of complex multiplications is then equal to:

$$\begin{aligned} C_{f-OFDM,*}^{SLM} &= V(C_{1,f-OFDM,*}^{SLM} + C_{2,f-OFDM,*}^{SLM} + C_{3,f-OFDM,*}^{SLM}) \\ &= V\left(\frac{3N}{2} \log_2(N) + 2(N + N_{CP}) \lfloor \frac{L}{2} \rfloor + (5N + 2N_{CP} + 5L - 5)\right) \end{aligned} \quad (3.46)$$

In terms of real additions, we have for following complexity:

$$C_{f-OFDM,+}^{SLM} = V(2N \log_2(N) + 2(N + N_{CP}) \lfloor \frac{L}{2} \rfloor) \quad (3.47)$$

3.2.5 BF-OFDM

We remind that, for this WF, the number of active subcarriers was fixed to $\frac{MN_{BF}}{2}$, in order to make fair comparison to other WFs. For each vector C^v , the SLM algorithm carries:

1. Multiplication of active subcarriers by vector C^v (complex rotations by $(+1, -1, +j, -j)$):

$$C_{1,BF-OFDM,*}^{SLM} = \frac{3MN_{BF}}{2} \quad (3.48)$$

$$C_{1,BF-OFDM,+}^{SLM} = 0 \quad (3.49)$$

2. Computation of output BF-OFDM signal in the time domain:

$$\begin{aligned} C_{2,BF-OFDM,*}^{SLM} = C_{BF-OFDM,Tx}^* &= 3B \frac{N_{BF}}{2} + 3B \frac{N_{BF}}{2} \left(1 + \log_2 \left(\frac{N_{BF}}{2} \right) \right) \\ &+ 2KM N_{BF} + 3N_{BF} \frac{M}{2} \log_2(M) \end{aligned} \quad (3.50)$$

where B is the number of active resource blocs of $N_{BF}/2$ subcarriers. As stated here before, the Tx complexity of BF-OFDM is equivalent to twice the one of CP-OFDM. We have thus:

$$C_{2,BF-OFDM,*}^{SLM} \sim \frac{3MN_{BF}}{2} \log_2 \left(\frac{MN_{BF}}{2} \right) \quad (3.51)$$

$$C_{2,BF-OFDM,+}^{SLM} = MN_{BF} \log_2 \left(\frac{MN_{BF}}{2} \right) \quad (3.52)$$

3. Computation of PAPR of the time domain signal:

$$C_{3,BF-OFDM,*}^{SLM} = \frac{3MN_{BF}}{2} \quad (3.53)$$

$$C_{3,BF-OFDM,+}^{SLM} = 0 \quad (3.54)$$

The total complexity in terms of real multiplications is then equal to:

$$\begin{aligned} C_{BF-OFDM,*}^{SLM} &= V(C_{1,BF-OFDM,*}^{SLM} + C_{2,BF-OFDM,*}^{SLM} + C_{3,BF-OFDM,*}^{SLM}) \quad (3.55) \\ &= V\left(\frac{3MN_{BF}}{2} \log_2 \left(\frac{MN_{BF}}{2} \right) + 3MN_{BF}\right) \end{aligned}$$

The total complexity in terms of real additions is then equal to:

$$\begin{aligned} C_{BF-OFDM,+}^{SLM} &= V(C_{1,BF-OFDM,+}^{SLM} + C_{2,BF-OFDM,+}^{SLM} + C_{3,BF-OFDM,+}^{SLM}) \quad (3.56) \\ &= V\left(MN_{BF} \log_2 \left(\frac{MN_{BF}}{2} \right)\right) \end{aligned}$$

Table 3-1: Normalized complexity of SLM algorithm with respect to CP-OFDM

| WF | CP-OFDM | WOLA-OFDM | UFMC | f-OFDM | BF-OFDM |
|-----------------------|---------|-----------|--------|--------|---------|
| Normalized complexity | 1 | 1,01 | 242,93 | 12,60 | 1,67 |

3.3 *Synthesis on complexity*

As an illustration of the previous analysis, we computed in table 3-1, the normalized complexity (related to real multiplications), with respect to CP-OFDM, of the SLM algorithm applied to WOLA-OFDM, UFMC, f-OFDM and BF-OFDM. This analysis is based on the simulation parameters of table 2-1 and is obviously independent from the number of complex phase rotation vectors V .

It's clear from the results given by table 3-1 that SLM applied to UFMC exhibits the highest complexity as compared to WOLA-OFDM, which requires mainly the same number of real multiplications as compared to CP-OFDM. It has to be noted that the SLM method includes the signal modulation (in fact, with SLM method, we compute the output modulated signal).

It should be noted that optimized implantation schemes have been proposed in the recent literature to reduce the UFMC Tx complexity [WS15]. However these schemes have not been considered in our analysis. In the other side BF-OFDM, has quite low complexity when compared f-OFDM (gain factor ~ 7.5)

4. Overall power budget evaluation

4.1 Objective

The objective of the study is to take benefit from the PAPR reduction method to increase the HPA efficiency and to drive the signal to be amplified closer to the saturation point of the power amplifier. As a result, the output power is increased and the signal can be transmitted on a larger area range. An other approach could be to keep the same input power while minimizing the PAPR. This results in an sub-dimensionning of the power amplifier. This second approach has not been used as the first one enables the increase of the transmission coverage the transmission coupled with a PAPR reduction.

4.2 Methodology

The objective is to estimate the power budget of the suggested transmission system taking into account the consumption of (i) the waveforms (ii) the PAPR reduction method used and (iii) the power amplifier. According to given input back-off ($IBO(V)$) and V values, the power added efficiency (PAE) η is defined as :

$$\eta_{PAE}((IBO(V))) = \frac{P_{out}((IBO(V))) - P_{in}((IBO(V)))}{P_{DC}((IBO(V))) + P_{SLM}(V)}, \quad (4.1)$$

where P_{in} , P_{out} and P_{DC} are the input, output and DC powers of the HPA for a given $(IBO(V))$ respectively. P_{SLM} is the power consumption of the SLM PAPR reduction method for a given number of sequences ϕ . First it has to be mentioned that $IBO(V)$ depends on V and decreases with the increase of the PAPR reduction gain in accordance to PAPR gains presented in the related CCDFs. The methodology is as follows :

- an initial IBO value is set (ie IBO_0) and the corresponding (Error Vector magnitude EVM_0 value is evaluated
- while applying the SLM PAPR reduction method with $\delta PAPR$ gain (for a given value of V), IBO_0 is updated to $IBO(V) = IBO_0 - \delta PAPR$ and the corresponding EVM value is updated to EVM_1
- it has to be checked that EVM_0 and EVM_1 have similar values

Besides, the SLM PAPR reduction method consumption was provided by a system generator tool which generates the VHDL code from a high level language of the processing (Matlab). The targeted board was a FPGA board from Xilinx Zedboard (FPGA Zynq-7000 AP SoC XC7Z020-CLG484). The following design flow was used :

- Step 1 : Simulink modeling environment whose inputs are the codes of the WFs and SLM method
- Step 2 : Vivado System Generator for DSP to release the VHDL architecture and the associated power consumption

Fig. 4-1 gives a picture of the layout provided by the system generator (here for CP-OFDM as an illustration).

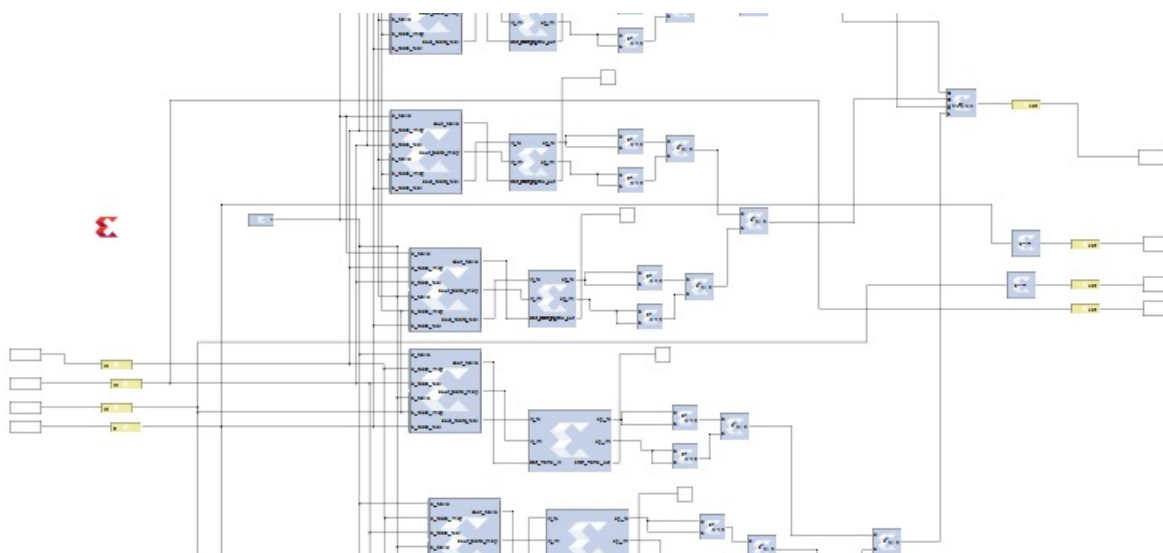

Figure 4-1: Layout from System Generator Vivado (here for CP-OFDM)

4.3 Simulation results

4.3.1 Consumption results of SLM method for all waveforms

Figs. 4-2 to 4-5 illustrate the power consumptions of the SLM method according to the number of branches V for the different WFs. This clearly shows that the total power (static + dynamic) increases with V as expected. The consumption results are coherent with the complexity evaluation : the larger the complexity, the larger the consumption. Please note that the consumption results do not consider any architecture optimization. As a result we think that there is room to decrease the consumption especially for UFMF (see Fig. 4-5) by investigating architecture issues (as parallelization).

4.3.2 HPA efficiency with SLM results

Efficiency results are sketched on Figs. 4-6, 4-7 and 4-8. For each waveform, three initial IBO were considered : 8, 10 and 12 dB. This means that starting from these IBO values, the SLM method was performed (from $V = 2$ to $V = 32$) and the IBO has been updated accordingly. And for each value of V , the power consumption of the SLM was evaluated and included in Equ.(4.1). First, as expected the larger the initial IBO value, the lower the efficiency. Second, it appears that efficiencies exhibit a maximum value which refers to the trade-off between the PAPR gain and the complexity of the associated SLM method. This remark holds for all waveforms. Before this maximum (V low), the PAPR gain provides a large HPA efficiency versus the complexity of SLM (V less than 10). But after this maximum, even though the PAPR gain is larger, as V increases, the associated SLM complexity and consumption is too large what penalizes the HPA efficiency.

Efficiency results are very similar between CP-OFDM, WOLA-OFDM and BF-OFDM as their respective complexities are of same order. The efficiency shows a maximum value of about 10% when the initial IBO is set to 8 dB. For the f-OFDM waveform, the

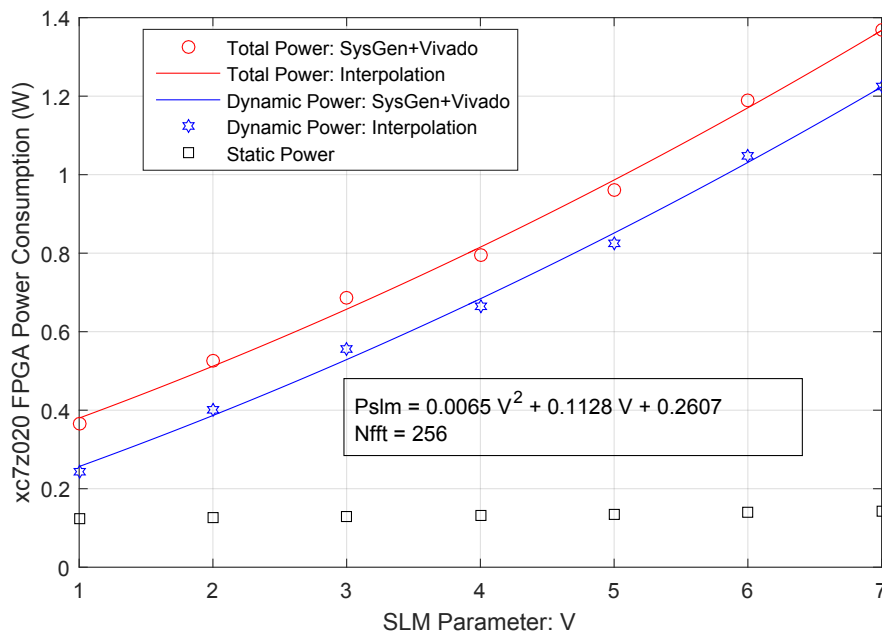

Figure 4-2: Power consumption - OFDM and WOLA-OFDM

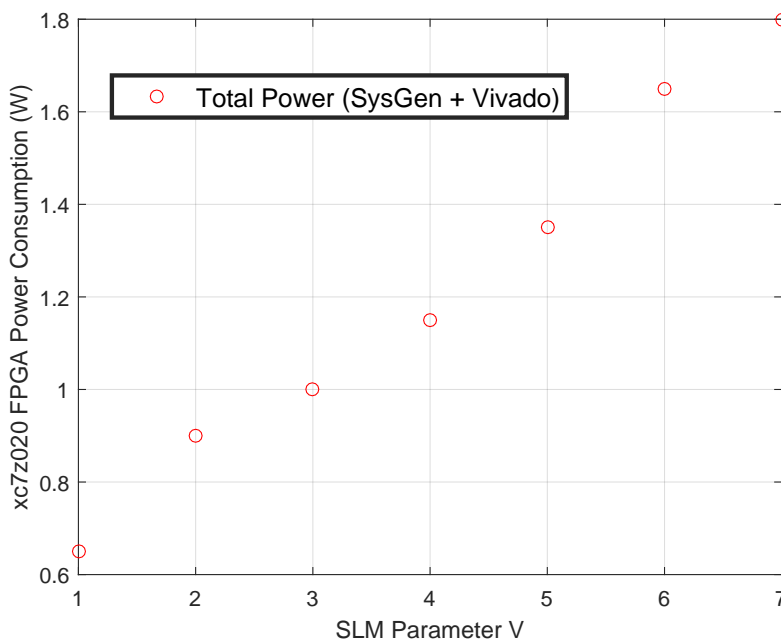

Figure 4-3: Power consumption - BF-OFDM

efficiency is less whatever the initial IBO value and the maximum efficiency value is below 6%. For the UPMC waveform, the efficiency results are not relevant at all for the power amplifier we used as the values are very low due to the high consumption as seen in Fig. 4-5. It appears that resulting efficiency is far below 1% whatever both the initial IBO and the SLM parameter V. As a result, UPMC is not well suited for this kind of power amplifier whose output power is of order 1 W.

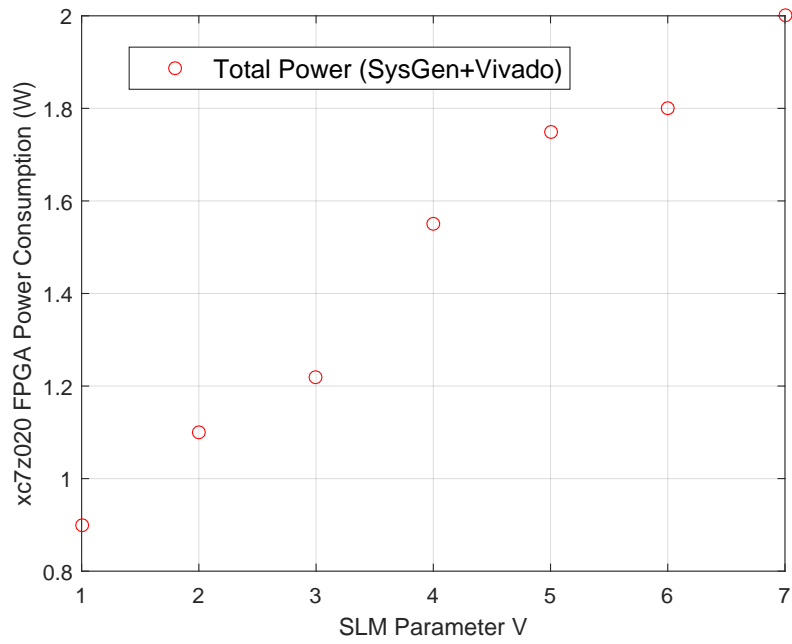

Figure 4-4: Power consumption - f-OFDM

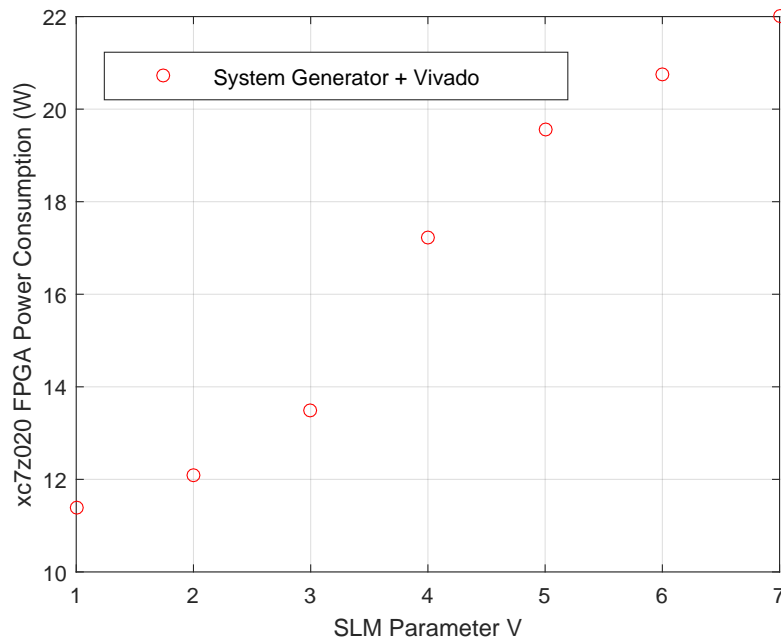

Figure 4-5: Power consumption - UFMC

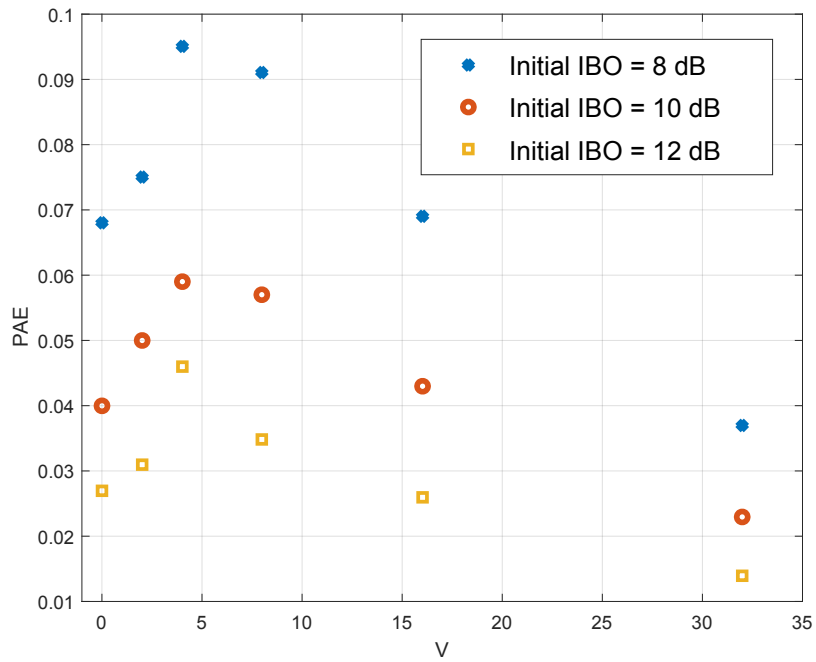

Figure 4-6: HPA efficiency for CP-OFDM and WOLA-OFDM

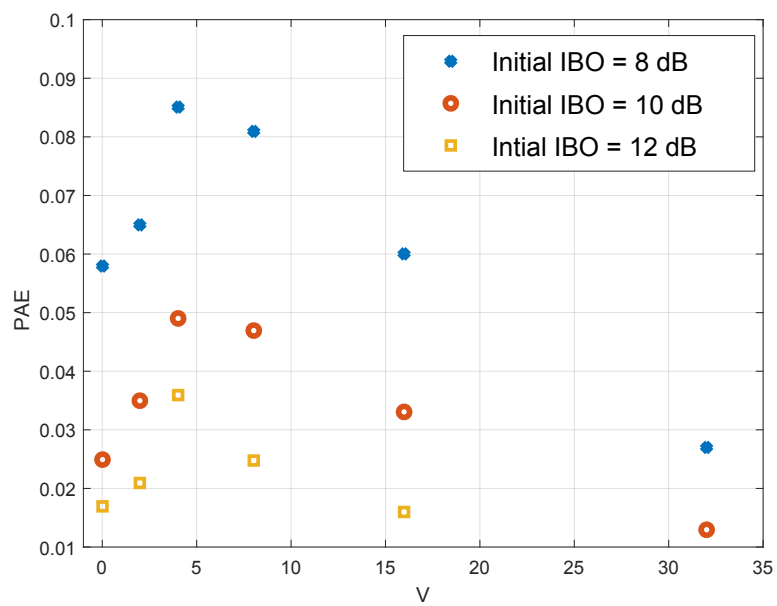

Figure 4-7: HPA efficiency for BF-OFDM

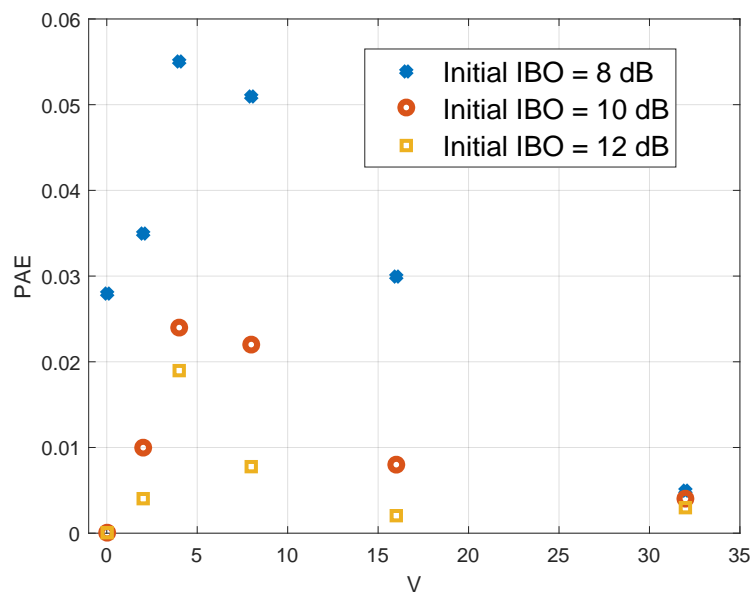

Figure 4-8: HPA efficiency for f-OFDM

5. Conclusion

This paper provides a study to estimate the efficiency of a power amplifier taking into account not only its consumption but also the consumption of the waveforms that come into play and for the PAPR reduction method (SLM). The power consumption of the processing have been evaluated with a software tool that generated the associated VHDL code and architecture from a high level description of the processing (Matlab codes). Results show that there is a trade-off between the PAPR method reduction gain and the complexity of the method. This trade-off is characterized by a peak in the overall efficiency. Results with OFDM, WOLA-OFDM, f-OFDM and BF-OFDM show roughly similar complexities what has been confirmed by derivations. UFMC associated to SLM is so complex that its power consumption shadows the overall efficiency. As a conclusion, several issues can be raised :

- the consumption simulations are in accordance with the complexity derivations for all waveforms associated to SLM : the more complex the PAPR reduction method, the more the consumption.
- while integrating the consumption figures in the overall power budget, it is shown that there is a trade-off between the PAPR reduction gain and the efficiency of the power amplifier. For low PAPR reduction gain, the complexity is low what results in a low power efficiency. At the opposite for large PAPR reduction gains, the complexity is large but the efficiency falls down. In between, there is an optimal PAPR reduction level which provides the largest efficiency. This has been observed for CP-OFDM, WOLA-OFDM, F-OFDM and BF-OFDM.
- it has to be mentioned that a PAPR reduction method is of potential interest only if its associated power consumption is of same order of magnitude or lower than the output HPA power. For the UFMC waveform, the SLM method is so complex that its power consumption (more than $10W$) lowers the efficiency by large what makes this waveform not suitable at all for a transmitter of about $1W$ of output power.
- If a HPA with a higher output power was used ($10W$ or $100W$ for example), it has to be noted that the maximum of the power efficiency will be shifted to higher values of V . In fact, with a higher HPA output power, the DC consumed power in the denominator of Equ. (4.1) will be very high and the consumed power by the SLM method could be negligible for low values of V .

6. References

- [BFH96] R. W. Bauml, R. F. H. Fischer, and J. B. Huber. Reducing the peak-to-average power ratio of multicarrier modulation by selected mapping. *IEEE Electronics Letters*, 32(22):2056–2057, Oct. 1996.
- [JNB18] C. A. Nour J. Nadal and A. Baghdadi. Novel uf-ofdm transmitter: Significant complexity reduction without signal approximation. *IEEE Transactions on Vehicular Technology*, 67:2141–2154, March. 2018.
- [JY08] T. Jiang and Y.Wu. An overview : Peak-to-average power ratio reduction techniques for ofdm signals. *IEEE Transactions on Broadcasting*, 2(54):257–268, June 2008.
- [Kra99] Steven G Krantz. *Handbook of Complex Variables*. Birkhäuser Basel, 1999.
- [LP08] Yves Louet and Jacques Palicot. A classification of methods for efficient power amplification of signals. *Annals of Telecommunications*, 7-8(63):351–368, Jul. 2008.
- [MTG⁺17] Y. Medjahdi, S. Traverso, R. Gerzaguët, H. ShaĀĒk, R. Zayani, D. Demmer, R. Zakaria, J. B. DorĀĀ, M. Ben Mabrouk, D. Le Ruyet, Y. LouĀĀt, and D. Roviras. On the road to 5g: Comparative study of physical layer in mtc context. *IEEE Access*, 5:26556–26581, 2017.
- [pro16] WONG5. Wong5 project. *Deliverable 2.1: Critical and comparative study of waveforms in c-mtc context*. ANR, Tech. Rep, 2016.
- [pro17a] WONG5. Wong5 project. *Deliverable 2.2: New waveforms for C-MTC context*. ANR, Tech. Rep, 2017.
- [pro17b] WONG5. Wong5 project. *Deliverable 3.1: Performance of the candidate waveforms in the presence of power amplifier*. ANR, Tech. Rep, 2017.
- [WS15] T. Wild and F. Schaich. A Reduced Complexity Transmitter for UF-OFDM. In *Proc. IEEE 81st Vehicular Technology Conference (VTC Spring)*, pages 1–6, May 2015.

Glossary and Definitions

| Acronym | Meaning |
|---------------------|---|
| AM/AM | amplitude to amplitude |
| AM/PM | amplitude to phase |
| BF-OFDM | Block Filtered OFDM |
| CP | Cyclic Prefix |
| FFT-FBMC | Fast Fourier Transform Filter Bank Multi-Carrier |
| f-OFDM | filtered-OFDM |
| HPA | High Power Amplifier |
| IBO | Input-Back-Off |
| FBMC-OQAM | FBMC with Offset Quadrature Modulation |
| OFDM | Orthogonal Frequency Division Multiplexing |
| PAPR | Peak to Average Power Ratio |
| SLM | Selective Mapping |
| UFMC (i.e. UF-OFDM) | Universal-Filtered Multi-Carrier (i.e. Universal-Filtered OFDM) |
| WF | WaveForm |
| WOLA-OFDM | Weighted Overlap and Add OFDM |