



**HAL**  
open science

# A metamodeling method to study the nonlinearity of building thermal behavior

Issa Jaffal, Christian Inard

► **To cite this version:**

Issa Jaffal, Christian Inard. A metamodeling method to study the nonlinearity of building thermal behavior. *Journal of Building Engineering*, 2020, 28, pp.101078. 10.1016/j.jobe.2019.101078. hal-02958390

**HAL Id: hal-02958390**

**<https://hal-cnam.archives-ouvertes.fr/hal-02958390>**

Submitted on 21 Jul 2022

**HAL** is a multi-disciplinary open access archive for the deposit and dissemination of scientific research documents, whether they are published or not. The documents may come from teaching and research institutions in France or abroad, or from public or private research centers.

L'archive ouverte pluridisciplinaire **HAL**, est destinée au dépôt et à la diffusion de documents scientifiques de niveau recherche, publiés ou non, émanant des établissements d'enseignement et de recherche français ou étrangers, des laboratoires publics ou privés.



Distributed under a Creative Commons Attribution - NonCommercial| 4.0 International License

# **A metamodeling method to study the nonlinearity of building thermal behavior**

Issa Jaffal<sup>1,\*</sup> and Christian Inard<sup>2</sup>

<sup>1</sup>*Laboratoire du Froid des Systèmes Energétiques et Thermiques (Lafset), Cnam,  
HESAM Université, Paris, France*

<sup>2</sup>*Laboratory of Engineering Sciences for the Environment (LaSIE), UMR CNRS 7356,  
La Rochelle University, La Rochelle, France*

*\* Corresponding author: Cnam, 292 rue Saint-Martin, 75003, Paris, France,  
issa.jaffal@lecnam.net*

## **Abstract**

Understanding the nonlinearity of the thermal behavior of buildings is important for their design and energy analysis. This paper presents a method for the study of nonlinearity building thermal behavior based on a metamodel for cooling energy needs. Four measures were introduced to assess nonlinearities using the metamodel coefficients. We studied the nonlinearity of the thermal behavior of an office. A higher accuracy was generally obtained for hot climates, high internal heat gains and lightweight thermal mass. Conversely, the nonlinearity of thermal behavior was accentuated in cold climates and with low internal heat gains. The nonlinearity measures were strongly associated to the mean outdoor air temperature in fifteen typical European climates using power laws using power laws with  $R^2$  ranging from 0.75 to 0.96. In addition, they were strongly associated to internal heat gains ( $R^2 > 0.96$ ) in the coldest climate and were low and almost stable in the hottest climate. Moreover, the interactions between the building components were more influential on cooling energy needs than quadratic behavior. A metamodel giving energy needs as a function of the

physical and geometric parameters was derived. Its extrapolation with various window-wall ratios generally gave an acceptable accuracy, with quadratic variation of the errors. We propose a classification of thermal behavior into three regimes: highly nonlinear when the energy needs are close to zero; intermediate with decreasing nonlinearities that can be expressed by power functions; and finally, a quasi-linear regime with almost-steady nonlinearities.

**Keywords:** building thermal behavior; cooling energy needs; metamodel; nonlinearity; interactions

## **1. Introduction**

Dynamic models describe the thermal behavior of a building with relatively high fidelity and can be used to explore design alternatives. However, despite their great potential, extensive studies such as those for building optimization, may require excessive computation times. In addition, their capacity to provide insight into thermal behavior is limited by the implicit nature of the heat transfer equations. Furthermore, their use during early design stages is constrained by the large amount of data required.

Metamodels have been developed to approximate simulation models [1], with a resulting improvement in computation efficiency and a better understanding of the original model. The simulations are simplified by the low computational expense of the metamodels. In addition, metamodels generally have explicit forms which provide insight into the nature of the simulation response as a function of the influential parameters. Moreover, they only require small amounts of data, which makes them suitable for early design stages.

The most common metamodeling strategy is to construct polynomial approximations

[2-4]. They are the simplest, require the lowest computational effort and give useful insight into the behavior of the model. Their coefficients are easy to interpret, highlighting the effects of the input parameters. The number of runs needed to fit them can be drastically reduced with the use of the Design of Experiments [5]. The choice of an experimental design determines the number of runs and the value of the design parameters in each run.

Several alternative metamodeling techniques can be used to approximate a model, notably artificial neural networks, radial basis functions, kriging, Multivariate Adaptive Regression Splines (MARS), support vector machines and Gaussian processes [2-4]. Generally, these techniques provide better fits than polynomials. However, they can be computationally intensive and provide less insight.

Hence, metamodels can improve the computation efficiency of building energy performance. They can also provide an interpretation of the dynamic model, especially when using polynomials. This allows a better understanding of the relationship between building design, environmental parameters and energy performance indicators.

Consequently, the development of metamodels to investigate building energy performance has become an active area of research. Polynomial regressions are the most widely used metamodels. They have been used to study the energy needs for cooling and heating [6-9], energy consumption [9-13] and CO<sub>2</sub> emissions [9]. Moreover, polynomial regressions have been developed to assess the impact of building energy consumption with climate change [14-16] and to estimate the energy consumption of the residential stock of the city of Rotterdam [17].

Furthermore, polynomial approximations have been used to study the free-running indoor temperature in buildings. They have also been developed to assess the indoor air

temperature in an urban area [18], the daily mean indoor temperature and relative humidity [19], the discomfort degree-hours [13] and overheating in future climates [20].

Polynomial approximations have also been used to formulate optimization problems. They have been developed for energy needs and indoor temperature in order to optimize building design that takes into account uncertainties [21] and to minimize heating and cooling loads using a non-sorting genetic algorithm [8]. In addition, the standardized regression coefficients of linear metamodels have been used to quantify the sensitivity of heating and cooling energy consumption to building design parameters [22].

Artificial neural networks have also been widely used for metamodeling heating and cooling loads [23] and energy consumption [24-27], indoor air temperature [26], percentage of annual discomfort hours [27] and comfort evaluated through the predicted percentage of dissatisfied (PPD) index [26]. In addition, several studies have highlighted the higher accuracy of neural networks as compared to linear regression, for example in assessing energy consumption and discomfort degree-hours [13], predicting energy needs, energy consumption and CO<sub>2</sub> emissions [9] as well as daily mean indoor temperature and relative humidity [19]. Moreover, artificial neural networks were found to perform better than radial basis functions when studying overheating and air pollution [28].

Various metamodeling techniques have been investigated for the study of building energy performance e.g. support vector machines to predict building energy consumption as a function of weather parameters [29]. A support vector machine was compared to three artificial neural networks for the prediction of hourly cooling load [30]. All the techniques were found to be effective, but the support vector machine was more accurate. Gaussian process metamodels were used to assess building energy

consumption for heating and cooling and were found to capture nonlinear behavior [31]. The MARS method improved the accuracy of linear regression metamodels when predicting illuminance level, air change rate and comfort time versus passive design parameters [32]. It has been demonstrated that the MARS method is more accurate than polynomial regressions when predicting energy demand and indoor temperature [21].

Some studies have compared several metamodeling methods in studying building energy performance. Polynomial regression, MARS, kriging, radial basis function networks and neural networks were compared when predicting energy needs for heating and overheating [33]. The computation efficiency of all the metamodels was highlighted and the MARS method was recommended because of its simplicity, although kriging and neural networks provide greater accuracy. Multiple linear regression, MARS, support vector machines, Gaussian process, random forests and artificial neural network metamodeling techniques have been compared in a study of cooling energy needs [34]. The artificial neural networks were recommended for building labelling in Brazil due to their higher accuracy. However, linear metamodels were found to have comparable accuracy to those of decision trees and artificial neural networks when predicting building energy consumption, although the last two performed slightly better [35].

Metamodels have been also used to study envelop components e.g. to calculate the U-values of lightweight hollow concrete bricks [36] and the linear thermal transmittance of thermal bridges [37], to study phase change material walls [38], to assess the thermal and economic performance of radiant barriers [39], to investigate the energy performance of double-glazed windows [40] and to improve the ventilation efficiency of window openings [41].

Building energy systems have also been investigated using metamodels, for instance to

optimize a solar cooling system [42], predict the sensible and latent cooling capacities of an earth to air heat exchanger [43], optimize an energy recovery ventilator [44], predict the energy production of photovoltaic systems [45] and for the adaptive and predictive control of thermo-active building systems [46].

Finally, metamodels have recently been introduced in Brazilian energy regulations to assess the energy performance of air-conditioned and naturally ventilated buildings [13], and they have been recommended for future Chilean energy standards [9].

The thermal behavior of a building is affected by nonlinearities. Heat transfer through walls is nonlinear in a transient regime. Heat transfer by convection and radiation is inherently nonlinear, although it is often linearized. The thermal behavior of the energy systems of a building is generally nonlinear. There are also interactions between heat transfers because the effect of one heat transfer on energy needs can depend on the level of another. For instance, the effect of a ventilation heat transfer in reducing the energy needs for cooling is greater when the solar and internal gains are high.

Consequently, developing methods for assessing the nonlinearities in the thermal behavior of a building is an interesting subject for research. These methods could be useful for evaluating the relevance of a building energy performance model, for choosing of a sensitivity analysis method and for improving optimization efficiency.

Nonlinearity has been investigated by simply changing one variable at time, such as in studying the impact of passive design measures on the building energy consumption for heating and cooling [47], the impact of uncertainties in building parameters on energy and economic performance [48] and energy consumption as a function of the U-values of walls [49]. Nonlinearity has also been highlighted in sensitivity analysis studies using the Morris method, for instance in the sensitivity analysis of the heating energy needs

with respect to building parameters [50] and of the heating energy demand and overheating hours with respect to weather variables [51].

Comparative studies have been conducted to confront linear and nonlinear regression metamodels. For instance, they have been developed to predict energy consumption as a function of the building and HVAC system parameters [52] and heating energy demand as a function of building envelope parameters [53]. These studies highlighted the higher accuracy of the nonlinear metamodels. However, the literature shows that there is a need for a general method to assess the nonlinearities of thermal behavior.

Thus, extensive work has been carried out on metamodels for the study of the energy performance of a building and its energy systems. These studies highlighted the accuracy and computational efficiency of metamodels, but their capability to provide insight into thermal behavior has not been sufficiently investigated. In particular, there is a lack of methods that use metamodels to study nonlinearities in thermal behavior. Our aim is to fill this gap by developing a general and simple method to assess these nonlinearities. Several criteria should be considered when developing such methods, notably the accuracy of the metamodel, its approximate cost and its ability to provide insight. The major steps are the choice of the metamodel form and the measures used to study nonlinearities, the choice of the experimental design, metamodel fitting and validation, and the analysis of nonlinearity measures.

Recently, we presented a general metamodel that can be used as a common framework for metamodeling building energy performance [54]. The metamodel was developed with the assumption that heat transfer was in a quasi-steady state regime, which enabled us to incorporate some knowledge of heat transfer. The metamodel is flexible and can be adapted to different building characteristics and different energy performance



aspects. In addition, its polynomial based form is adapted to provide insight into thermal behavior.

Here we present a method for the study of nonlinearities in the thermal behavior of a building based on a metamodel for the cooling energy needs derived from the general metamodel [54]. In order to assess these nonlinearities, we introduced four measures based on the metamodel coefficients. The metamodel was fitted from dynamic simulation using a Box-Behnken experimental design. The nonlinearities in the thermal behavior on an office were analyzed for fifteen typical European climates after metamodel validation. Moreover, the method was applied to the cold climate of Helsinki and the hot climate of Athens with various levels of internal heat gains.

## 2. Methods

### 2.1. Metamodeling

This study presents a method to study the nonlinearities in the thermal behavior of a building based on a metamodel for cooling energy needs. The metamodel was derived from the general metamodel for building energy performance that we presented previously [54]. The derivation was achieved by considering the cooling energy needs  $Q_c$  as a performance indicator. Hence, the energy needs are a second-order polynomial of the individual energy needs for cooling  $\mathbf{Q} = (Q_1, Q_2, \dots, Q_n)$  the building components, which is expressed as follows:

$$Q_c = a_0 + \sum_{i=1}^n a_i Q_i + \sum_{i=1}^n a_{ii} Q_i^2 + \sum_{i=1}^{n-1} \sum_{j=i+1}^n a_{ij} Q_i Q_j + \varepsilon \quad (1)$$

where  $Q_i$  and  $Q_j$  are two individual energy needs equal to two heat transfers (kWh year<sup>-1</sup>),  $a_0$  is the metamodel constant,  $a_i$ ,  $a_{ii}$ , and  $a_{ij}$  are the linear, quadratic and interaction

effects, respectively and  $\varepsilon$  is the residual.

The metamodel coefficients  $a_0$ ,  $a_i$ ,  $a_{ii}$ , and  $a_{ij}$  are assumed to depend on climate, the thermal mass of the building, its use and the type of energy system. They incorporate the effect of the thermal mass since they are obtained from dynamic simulation. When all the individual energy needs of all the building components vary,  $a_0$  is equal to zero. In the opposite case, the metamodel coefficients are dependent on the individual energy needs that are assumed to be constant.

A transmission energy need for a wall is calculated in a quasi-steady-state assumption as

$$Q_{tr} = \sum UA(\theta_{is} - \theta_{oe})\Delta t \quad (2)$$

where  $U$  and  $A$  are the U-value ( $\text{W m}^{-2} \text{K}^{-1}$ ) and the area of the wall ( $\text{m}^2$ ), respectively,  $\theta_{is}$  is the indoor set-point temperature ( $^{\circ}\text{C}$ ),  $\theta_{oe}$  is the equivalent outdoor temperature to which the wall is exposed ( $^{\circ}\text{C}$ ) and  $\Delta t$  is the time step (h).

The energy need of an air change is given by

$$Q_{ac} = \sum \rho_a c_{pa} q_{v,ac} (\theta_{is} - \theta_{oa}) \Delta t \quad (3)$$

where  $q_{v,ac}$  is the airflow rate ( $\text{m}^3 \text{s}^{-1}$ ),  $\rho_a$  and  $c_{pa}$  are the air density ( $\text{kg m}^{-3}$ ) and specific heat capacity ( $\text{J kg}^{-1} \text{K}^{-1}$ ), respectively, and  $\theta_{oa}$  is the outdoor air temperature ( $^{\circ}\text{C}$ ).

The individual energy need with a solar heat gain through a window can be expressed as

$$Q_{so} = \sum F_{ish} F_{esh} SHGC_w I_{sw} A_w \Delta t \quad (4)$$

where  $SHGC_w$  and  $A_w$  are the solar heat gain coefficient and the area of the window

( $\text{m}^2$ ), respectively,  $I_{sw}$  is the solar irradiance in the direction of the window ( $\text{W m}^{-2}$ ) and  $F_{ish}$  and  $F_{esh}$  are the reduction factors of the internal and external shading devices, respectively.

## 2.2. Nonlinearity measures

The nonlinearities in thermal behavior were analyzed based on the interpretation of the metamodel coefficients. To this end, we introduced the following measures, which quantify the importance of the quadratic and interaction effects.

The ratio of the mean absolute value of quadratic to linear effects is given by

$$QL_{MA} = \frac{\sum_{i=1}^n |a_{ii}|}{\sum_{i=1}^n |a_i|} \quad (5)$$

where  $a_i$  is the effect of a linear term,  $a_{ii}$  is the effect of a quadratic term and  $n$  is the number of linear terms equal to the number of quadratic terms.

The ratio of the mean absolute value of interaction to linear effects is calculated from

$$IL_{MA} = \frac{n_i \sum_{i=1}^{n-1} \sum_{j=i+1}^n |a_{ij}|}{n_{ij} \sum_{i=1}^n |a_i|} \quad (6)$$

where  $a_{ij}$  is the effect of an interaction term and  $n_{ij} = n_i(n_i - 1)/2$  is the number of interaction terms.

The ratio of the root mean square of quadratic to linear effects is calculated from

$$QL_{RMS} = \frac{\sqrt{\sum_{i=1}^n a_{ii}^2}}{\sqrt{\sum_{i=1}^n a_i^2}} \quad (7)$$

Finally, the ratio of the root mean square of interaction to linear effects is given by

$$IL_{RMS} = \frac{\sqrt{n_i \sum_{i=1}^{n-1} \sum_{j=i+1}^n a_{ij}^2}}{\sqrt{n_{ij} \sum_{i=1}^n a_i^2}} \quad (8)$$

The ratios using mean absolute values  $QL_{MA}$  and  $IL_{MA}$  give the same weight to all effects of a similar type (linear, quadratic and interaction). They are more appropriate for the physical interpretation of the nonlinearities than  $QL_{RMS}$  and  $IL_{RMS}$ . However, the latter measures emphasize strong effects by giving them relatively high weights. In addition, their use avoids the use of absolute values, which are undesirable in many mathematical calculations.

### 2.3. Case study

The metamodel for cooling energy needs was used to study the nonlinearity of the thermal behavior of the office shown in Fig. 1. The energy needs were assessed for the period from June to September. The office has a concrete structure. Two types of thermal mass were considered: a lightweight thermal mass with insulation from the inside, and a heavy thermal mass with insulation from the outside.

The office is occupied from Monday to Friday from 8h to 18h. The ventilation air flow is equal to  $50 \text{ m}^3 \text{ h}^{-1}$  when the office is occupied. The cooling set-point temperature is  $26 \text{ }^\circ\text{C}$  when the office is occupied and  $30 \text{ }^\circ\text{C}$  when it is unoccupied. Moreover, the basic value of the internal heat gains is  $20 \text{ W m}^{-2}$  when the office is occupied and  $2 \text{ W m}^{-2}$  when it is unoccupied.

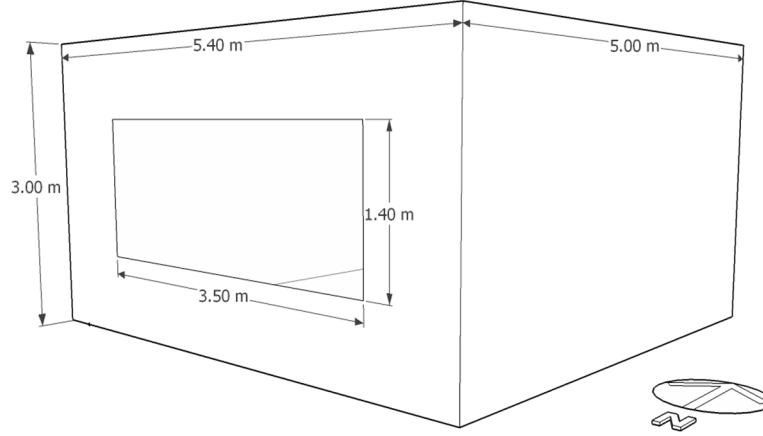

Fig. 1. The studied office.

We studied the impact of the facade components on cooling energy needs. Consequently, we analyzed individual energy needs corresponding to four heat transfers. These are shown in Table 1, with the parameters in Eqs. (2)-(4) varied to fit the metamodel.

The infiltration air flow rate is dependent on the wind speed and calculated from [55]:

$$q_{v,inf} = 0.224 q_{v,inf,r} v_w \quad (9)$$

where  $q_{v,inf,r}$  is the reference infiltration rate ( $\text{m}^3 \text{h}^{-1}$ ) and  $v_w$  is the wind speed ( $\text{m s}^{-1}$ ).

Table 1. Heat transfers, individual energy needs and the parameters varied to fit the

N°	Heat transfer	Individual energy need	Parameter varied
1	Transmission through the opaque wall incorporating the effect of the thermal bridges	$Q_{tr,wo}$ (kWh year <sup>-1</sup> )	$U_{ow}$ (W m <sup>-2</sup> K <sup>-1</sup> )
2	Transmission through the window	$Q_{tr,w}$ (kWh year <sup>-1</sup> )	$U_w$ (W m <sup>-2</sup> K <sup>-1</sup> )
3	Solar heat gain through the window	$Q_{so,w}$ (kWh year <sup>-1</sup> )	$q_{v,inf}$ (m <sup>3</sup> h <sup>-1</sup> )
4	Heat transfer due to infiltration	$Q_{ac,inf}$ (kWh year <sup>-1</sup> )	$SHGC_w$

metamodel.

Table 2. Lower and upper levels of the physical parameters.

N°	1	2	3	4
----	---	---	---	---

Parameter	Coded values	$U_{ow}$ (W m <sup>-2</sup> K <sup>-1</sup> )	$U_w$ (W m <sup>-2</sup> K <sup>-1</sup> )	$q_{v,inf,r}$ (m <sup>3</sup> h <sup>-1</sup> )	$SHGC_{w,r}$ -
Lower level	-1	0.1	0.7	8.1	0.3
Upper level	+1	0.5	2.7	32.4	0.7

The solar heat gain coefficient  $SHGC_w$  of the window is dependent on the solar angle of incidence  $\alpha_w$  as follows [56]:

$$SHGC_w = SHGC_{w,r} \frac{0.84 I_{sw,d} + I_{sw,D} \cos^{1/2} \alpha_w}{I_{sw}} \quad (10)$$

where  $I_{sw}$ ,  $I_{sw,d}$  and  $I_{sw,D}$  are the total, diffuse and direct solar irradiance in the direction of the window (W m<sup>-2</sup>), respectively.

Moreover, an external shading device was included. It provides a shading factor  $F_{om} = 0.2$  when the solar irradiance  $I_{sw}$  is higher than 300 W m<sup>-2</sup>.

The metamodel was fitted from dynamic simulations performed with TRNSYS software [56], which uses the response factor method proposed by Stephenson and Mitalas [57] to calculate heat transfer through walls. To this end, the individual energy needs were varied using upper and lower levels of the physical parameters, as shown in Table 2. The Box-Behnken experimental design was used to plan the simulations [58]. Hence, 25 dynamic simulations were needed to fit the metamodel compared with 81 when using a full factorial design. In addition, the metamodel coefficients were obtained by multiple regression analysis.

Next, the metamodel fit was tested by comparing the results with those of the TRNSYS dynamic simulations. The comparison was performed for 100 additional dynamic simulations with a random combination of the physical parameters of Table 2. To this end, the root mean square error ( $RMSE$ ) of the metamodel was used, which is given by

$$RMSE = \sqrt{\frac{\sum_1^{n_t} \epsilon_i^2}{n_t}} \quad (11)$$

where  $\varepsilon_i$  is a residual (Eq. (1)) and  $n_t$  is the number of simulations used to test the metamodel ( $n_t = 100$ ).

Once the metamodel had been fitted and validated, the nonlinearities in thermal behavior were studied using the measures of Eqs (5)-(8). The values of these measures were calculated using coded variables of the individual energy needs ranging from -1 to +1. The nonlinearities were hence analyzed using individual energy needs having the same variation range.

The metamodel was first applied to fifteen typical European climates, then for the cold climate of Helsinki and the hot climate of Athens. In the second part, the cooling energy needs and the nonlinearities in thermal behavior were studied in relation to internal heat gains  $p_{ig,o}$  of between 5 and 40 W m<sup>-2</sup> during occupation, at increments of 5 W m<sup>-2</sup>. In addition, internal heat gains when unoccupied were 10 % of  $p_{ig,o}$ . In each case, the mean value of cooling energy needs was considered to be equal to the mean of the 100 dynamic simulations used to test the metamodel fit.

### **3. Results and discussion**

#### ***3.1. Application to typical European climates***

As specified previously, the metamodel was applied to fifteen typical European climates. The mean outdoor air temperature in the corresponding locations and the mean cooling energy needs are presented in Fig. 2. The cooling energy needs varied between 271.1 and 810.9 kWh year<sup>-1</sup> for the lightweight thermal mass and between 215.3 and 871.8 kWh year<sup>-1</sup> for the heavy thermal mass. In addition, the results indicate that the thermal mass decreased the energy needs in cold climates and increased it in hot climates.

The variation of the *RMSE* of the metamodel versus the mean outdoor air temperature in the different locations for the lightweight and heavy thermal masses is presented in Fig. 3. The *RMSE* generally decreased with the temperature and thermal mass. Moreover, the *RMSE* varied between 0.4 and 1.4 kWh year<sup>-1</sup> for the lightweight thermal mass and between 0.9 and 3.5 kWh year<sup>-1</sup> for the heavy thermal mass. It was, in general, very low compared to the energy needs, especially for the lightweight thermal mass.

One reason for the higher accuracy with the lightweight thermal mass could be the quasi-steady state calculation of the individual energy needs in Eqs. (2)-(4), which may be more accurate with a lightweight thermal mass.

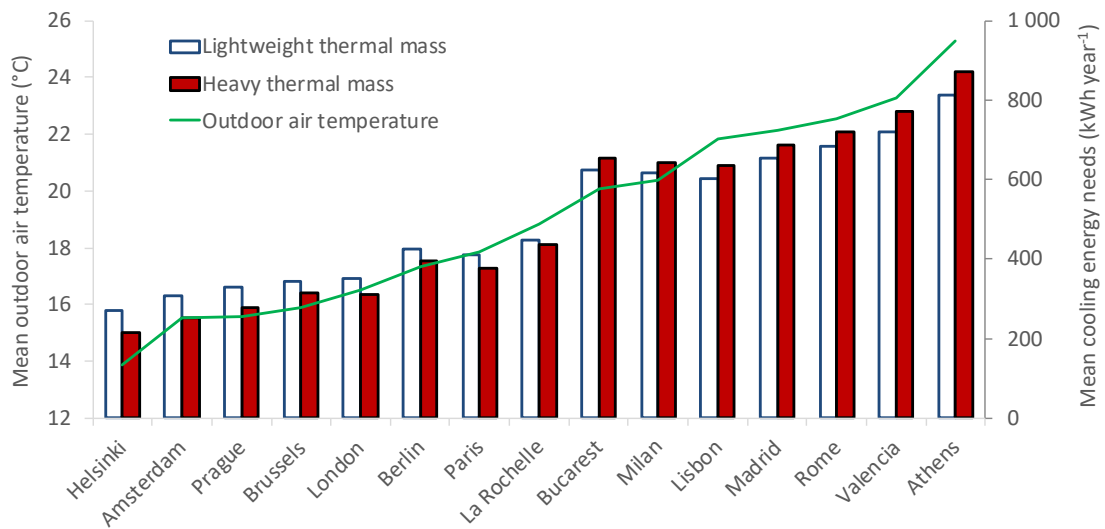

Fig. 2. Mean outdoor air temperature and mean cooling energy needs for fifteen typical European climates.



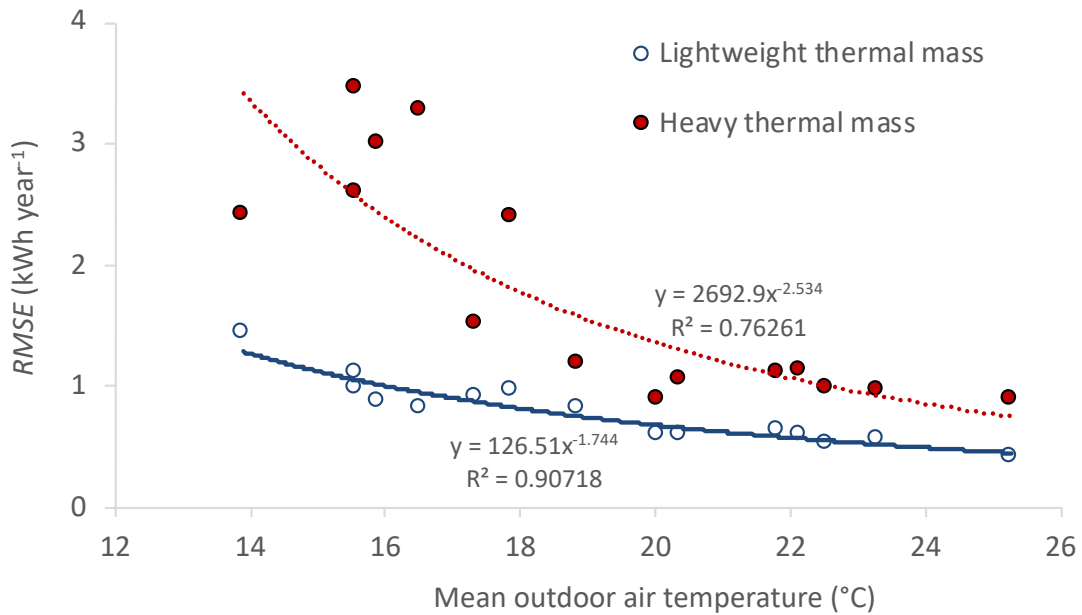

Fig. 3. *RMSE* of the metamodel for cooling energy needs versus the mean outdoor air temperature for the fifteen European climates.

An association was found between the *RMSE* and the outdoor air temperature following a power law. The corresponding coefficients of determination  $R^2$  were 0.90718 and 0.76261 for the lightweight and heavy thermal mass, respectively, which indicates that almost 91% and 76%, respectively, of the variation in the *RMSE* was associated with the outdoor air temperature.

The weaker association with the heavy thermal mass can be explained by the fact that with a heavy thermal mass, other climate factors have more influence on the nonlinearities, notably solar irradiation and the temperature difference between day and night.

The nonlinearity was also calculated for each climate. The ratios of quadratic to linear effects  $QL_{MA}$  and  $QL_{RMS}$  as a function of the mean outdoor air temperature are illustrated in Fig. 4. Similarly, the ratios of interaction to linear effects  $IL_{MA}$  and  $IL_{RMS}$  are illustrated in Fig. 5.

The results indicate that nonlinearities decreased, following a similar pattern, as a function of the outdoor air temperature. In addition, for a given climate, when the ratio of quadratic to linear effects was above or below the fitted curve, the corresponding ratio of interaction to linear effects generally followed the same tendency.

It is interesting to observe that, for each climate, the ratio of interaction to linear effects was higher than quadratic to linear effects. Thus, despite the quadratic behavior, the interaction between the components had a greater effect on energy needs.

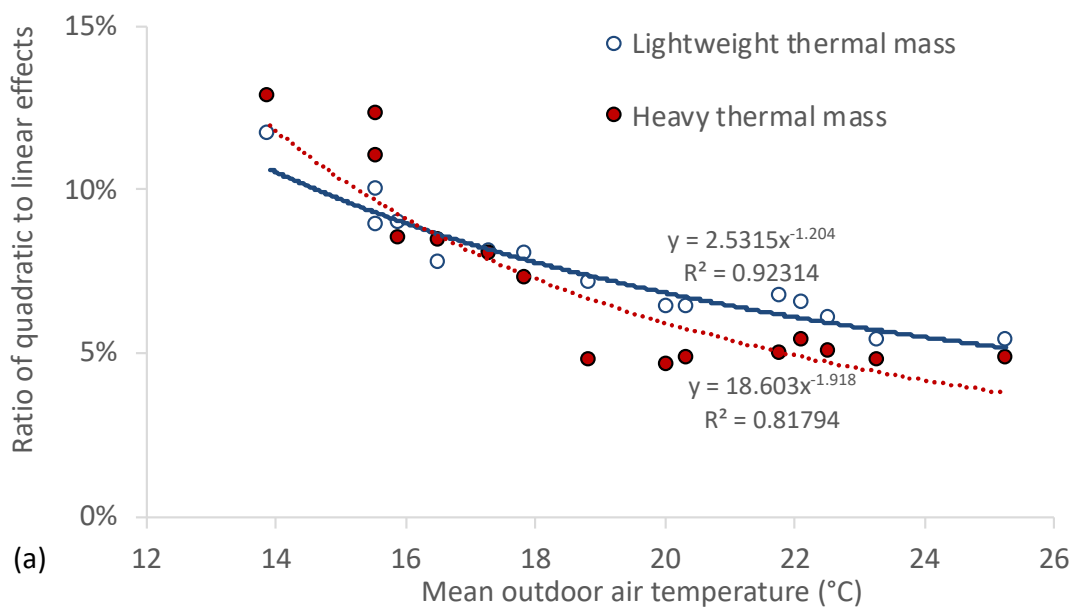

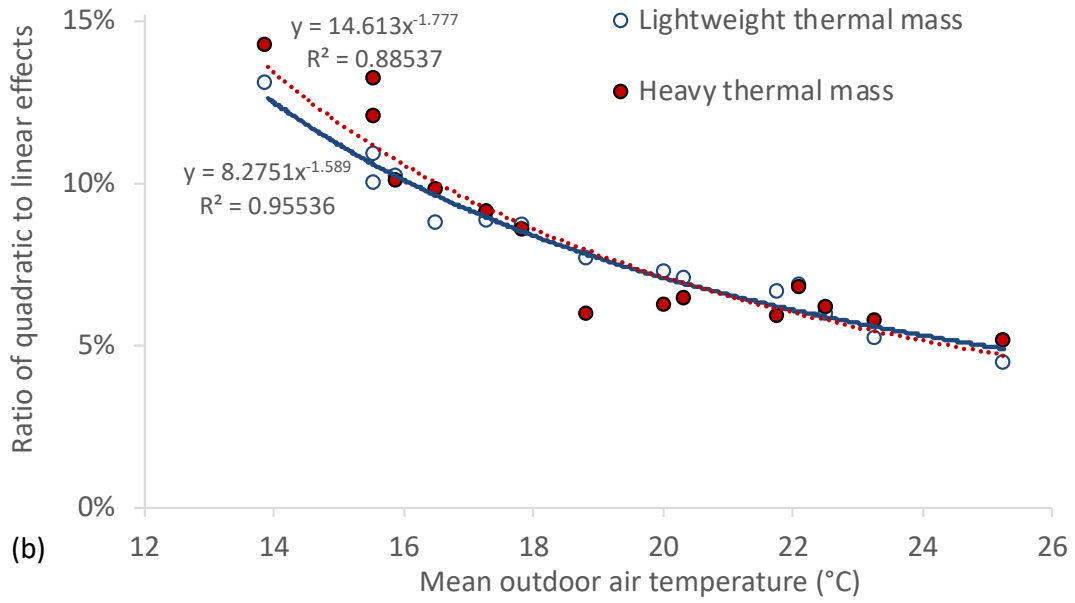
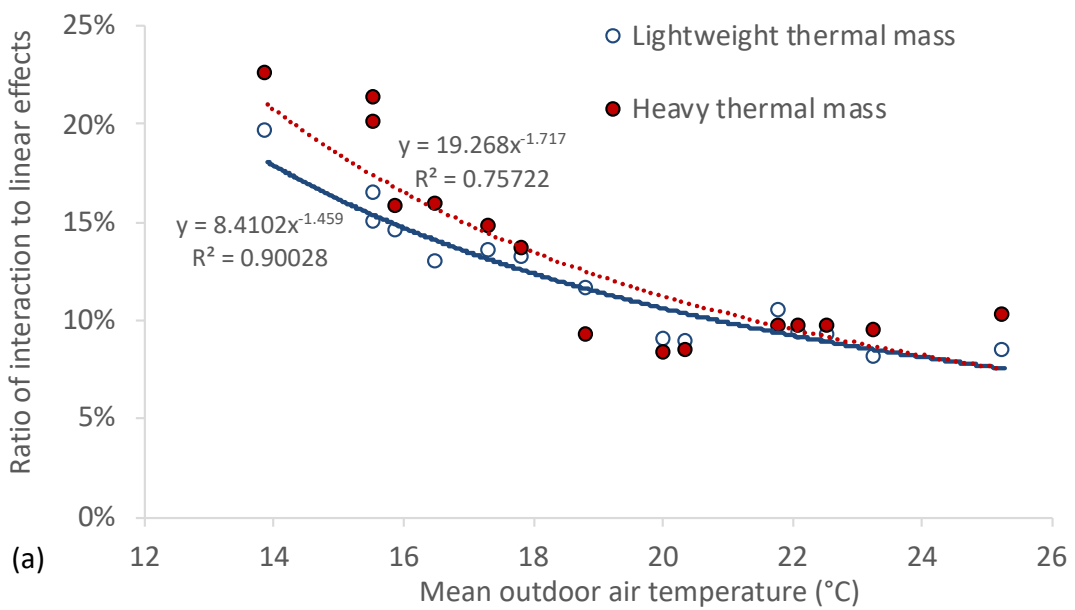

Fig. 4. Ratio of quadratic to linear effects versus mean outdoor air temperature for the fifteen European climates: (a) absolute value and (b) root mean square.



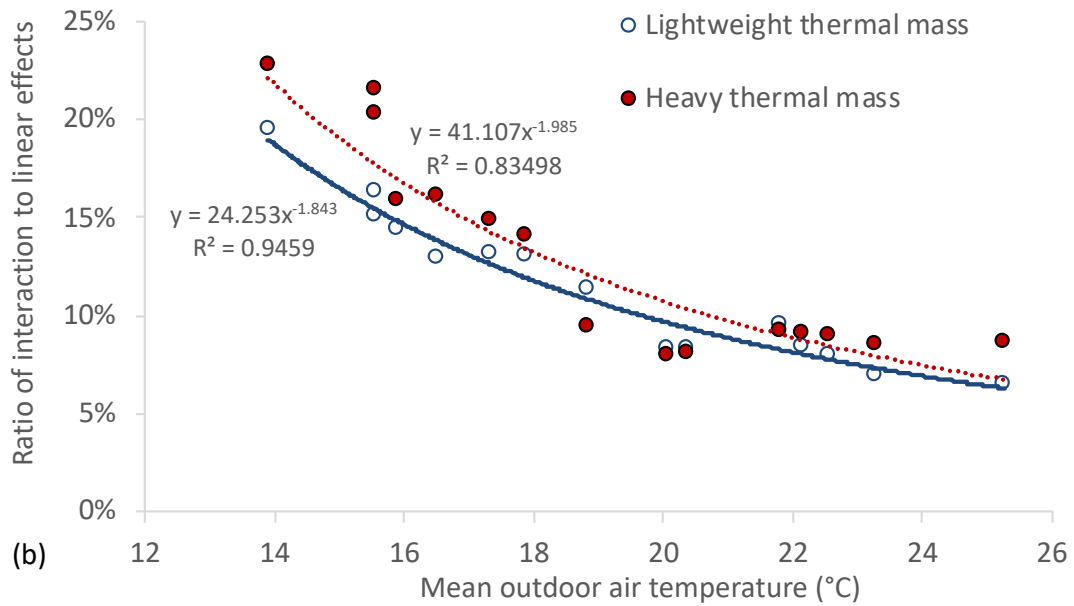

Fig. 5. Ratio of interaction to linear effects versus the mean outdoor air temperature for the fifteen European climates: (a) absolute value and (b) root mean square.

Table 3. Upper and lower levels of the individual cooling energy needs for Athens and Helsinki expressed in kWh year<sup>-1</sup>.

Location	Level	Coded value	$Q_{ir,ow}$	$Q_{tr,w}$	$Q_{ac,inf}$	$Q_{so,w}$
Helsinki	Lower	-1	46.5	159.0	105.0	235.2
	Upper	+1	232.6	613.1	420.0	548.8
Athens	Lower	-1	9.4	45.6	25.9	227.6
	Upper	+1	47.2	175.8	103.6	531.1

In addition, little variation was observed in the ratios above 19 °C, especially for the heavy thermal mass, indicating that the nonlinearities in thermal behavior become quasi-stable.

Furthermore, there was generally a strong association between ratio and outdoor air temperature, which varied between 76% and 96% depending on the measure. However, this temperature is not the only climate factor that impacted the nonlinearities in thermal behavior. The influence of other parameters such as the temperature difference between day and night, solar irradiation and wind speed could be significant. Further studies to investigate these effects would be interesting.

In the next section, further analysis is presented for the coldest climate, Helsinki, and the hottest climate, Athens.

### ***3.2. Application to cold and hot climates***

#### *3.2.1. Cooling energy needs*

The metamodel was used to study the nonlinearities in thermal behavior in the cold climate of Helsinki and the hot climate of Athens with internal heat gains during occupation  $p_{ig,o}$  varying from 5 to 40 W m<sup>-2</sup>. First, Table 3 shows the lower and upper levels of the individual cooling energy needs for both climates. These values were calculated using Eqs. (2)-(4) and obtained by varying the values of the physical parameters in Table 2.

The results showed that all the individual energy needs were positive. This suggests that, in both climates, heat transfer by transmission and air change correspond to heat losses, i.e. the heat is transferred mostly from inside to outside. It should be noted that solar heat gain through the window  $Q_{so,w}$  was higher in Helsinki than in Athens due to the shading device, which reduced the solar irradiance transmitted through the window by 80% when the solar irradiance was higher than 300 W m<sup>-2</sup>.

The mean cooling energy needs as given by dynamic simulation versus internal heat gains are illustrated in Fig. 6 for both climates and for lightweight and heavy thermal masses. The variation of the energy needs as a function of  $p_{ig,o}$  fitted almost perfectly with quadratic and linear polynomials for Helsinki and Athens, respectively.

It should be noticed that the heavy thermal mass reduced the cooling energy needs in Helsinki but increased them in Athens. The difference in energy needs was higher when the internal heat gains were intermediate in Helsinki and high in Athens.

The results also showed that, for Helsinki, when  $p_{ig,o}$  are equal to  $5 \text{ W m}^{-2}$ , the energy needs were close to zero for both thermal masses. Hence, in this case, the solar and internal heat gains were almost completely compensated by heat transfer by transmission and air change.

### 3.2.2. Metamodel coefficients

The metamodel coefficients were obtained by multiple regression analysis. A metamodel fit was achieved for each level of internal heat gains  $p_{ig,o}$ . However, the metamodel coefficients are presented only for the case where  $p_{ig,o}$  were  $20 \text{ W m}^{-2}$ . The coefficients for both climates and both thermal masses are shown in Table 4. These values are related to the metamodel with coded variables of the individual energy needs (varying from -1 to +1).

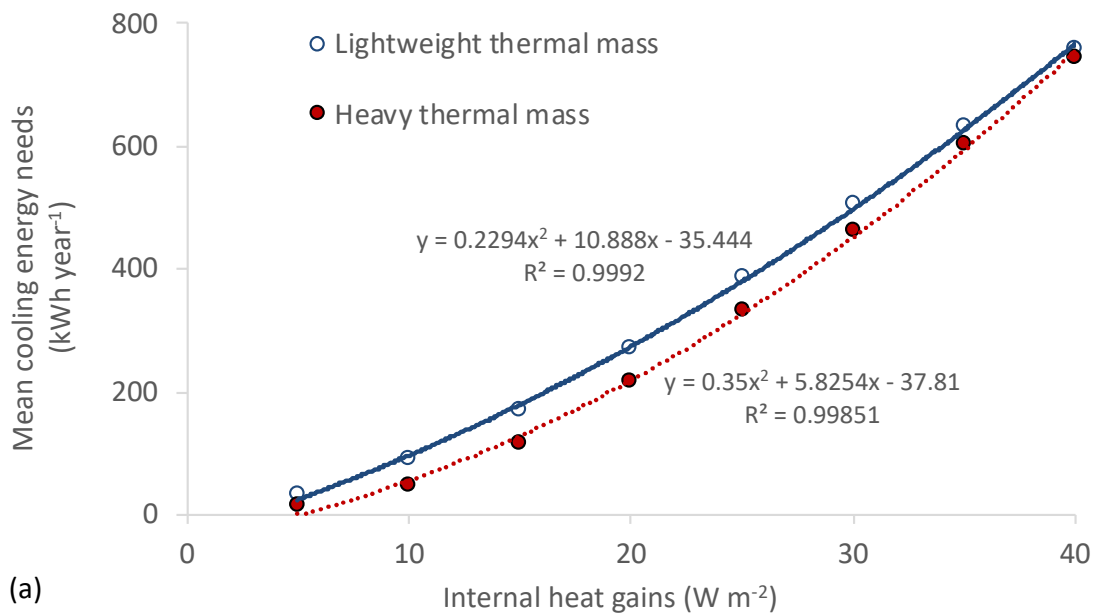

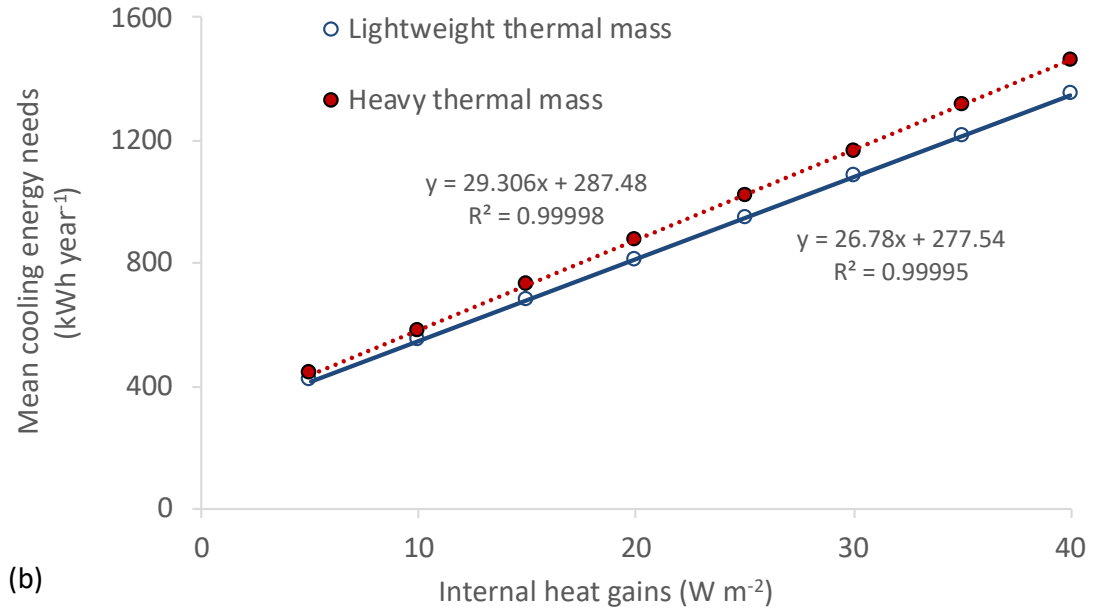

Fig. 6. Mean cooling energy needs as given by dynamic simulation versus internal heat gains: (a) Helsinki and (b) Athens.

Table 4. Coefficients of the metamodels using coded variables for Athens and Helsinki with internal heat gains of  $20 W m^{-2}$ .

Location	Helsinki		Athens	
	Lightweight	Heavy	Lightweight	Heavy
Thermal mass				
$a_0$	267.4	209.2	810.4	872.6
$a_1$	-38.0	-51.4	-13.3	-19.8
$a_2$	-92.0	-126.3	-37.4	-57.0
$a_3$	-58.3	-86.7	-13.5	-27.9
$a_4$	101.3	113.4	127.1	134.5
$a_{11}$	2.4	4.6	0.6	0.9
$a_{22}$	17.2	23.5	4.8	6.6
$a_{33}$	8.2	12.7	2.6	3.8
$a_{44}$	6.0	7.4	2.3	0.2
$a_{12}$	14.8	20.0	3.4	5.6
$a_{13}$	9.2	14.3	2.1	3.9
$a_{14}$	-8.9	-12.4	-2.8	-4.1

$a_{23}$	21.4	33.3	6.3	9.9
$a_{24}$	-18.8	-27.7	-5.9	-7.8
$a_{34}$	-12.2	-19.7	-3.7	-5.3

The coefficient  $a_0$  corresponds to the cooling energy needs when all the coded values of the individual energy needs are null, i.e. when they are equal to their mean level. Obviously, these energy needs were very high in the hot climate of Athens compared to the climate of Helsinki. In addition, at this level, the thermal mass reduced the energy needs in Helsinki and, conversely, increased them in Athens.

The coefficients  $a_1$ ,  $a_2$  and  $a_3$ , which correspond to the linear effects of the energy needs of heat transfer by transmission and air change  $Q_{tr,ow}$ ,  $Q_{tr,w}$  and  $Q_{ac,inf}$ , were negative. This suggests that this heat transfer reduces the cooling energy needs in both climates. The values were higher in Helsinki, the main reason being that the difference between the upper and lower levels of heat transfer is much higher in Helsinki (Table 3). Moreover, these effects were also higher with a heavy thermal mass, in accordance with the fact that the reduction in cooling energy needs is more sensitive to heat loss with a heavy thermal mass.

In addition, all of each quadratic term had a positive effect  $a_{ii}$ , suggesting that the cooling energy needs varied as a convex function of the individual energy needs. Furthermore, the effects of the interactions between the heat losses  $a_{12}$ ,  $a_{13}$  and  $a_{23}$  were all positive, highlighting the fact that the impact of a heat loss in reducing energy needs is higher when the other heat losses are low. This is because when heat loss is high, less of them would be needed to reduce the cooling energy needs.

Conversely, the effects of the interactions between the heat losses and the solar heat gain  $a_{14}$ ,  $a_{24}$  and  $a_{34}$  had negative values, which means that a higher portion of the heat losses was used to reduce the cooling energy needs when the solar heat gain was higher.



### 3.2.3. Metamodel validation

The metamodel fit was checked for each value of the internal heat gains  $p_{ig,o}$  by comparing the results with those of TRNSYS software. The *RMSE* of the fits are shown in Fig. 7 for both climates and both thermal masses. As expected, the metamodels were more accurate for the hot climate of Athens than for the cold climate of Helsinki and for the lightweight thermal mass.

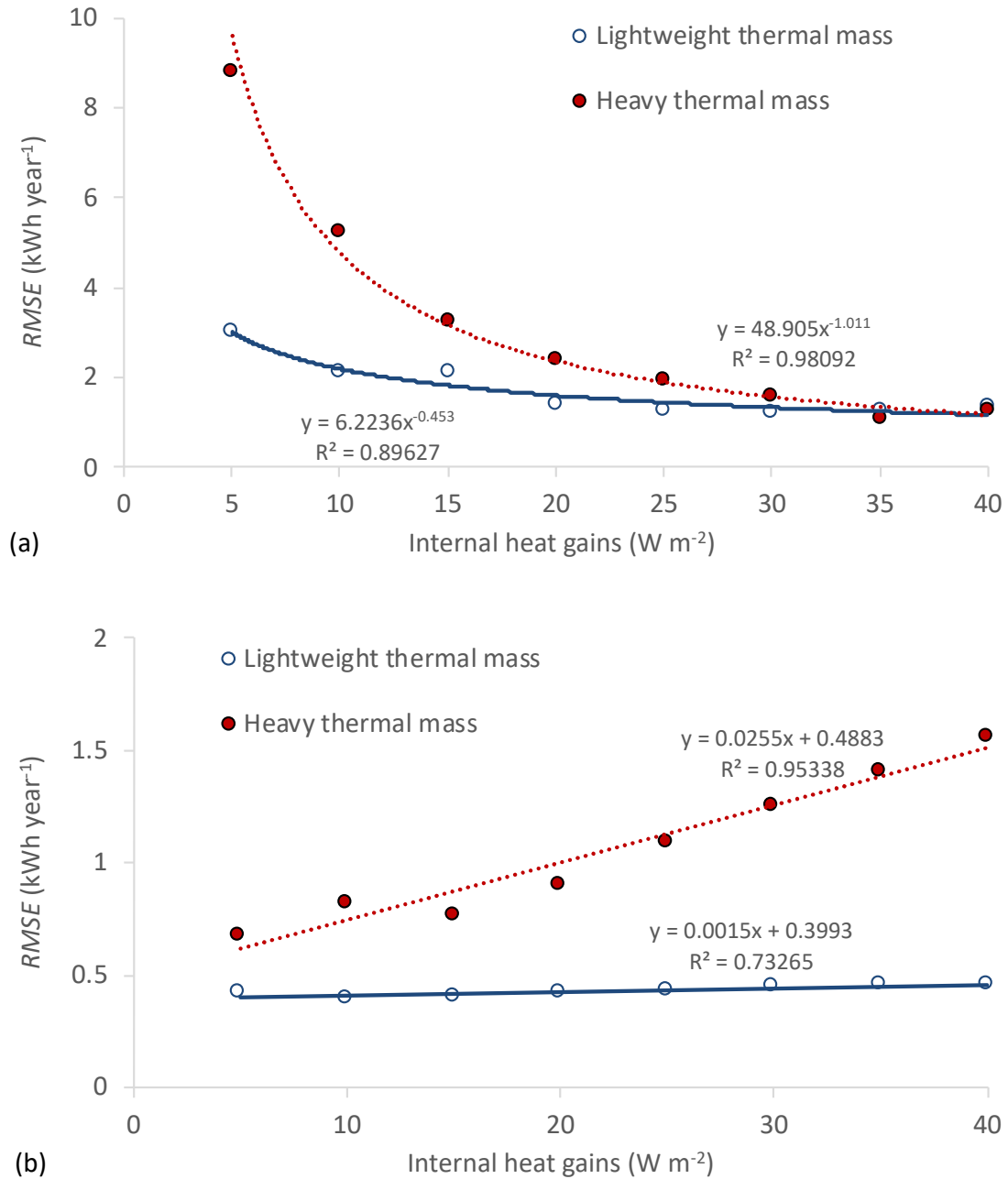

Fig. 7. *RMSE* of the metamodel for cooling energy needs versus internal heat gains: (a) Helsinki and (b) Athens.

For Helsinki, the *RMSE* was relatively high when the internal heat gains were low, i.e. when the cooling energy needs were close to zero. However, when these gains were high, the *RMSE* was low, comparable to the *RMSE* obtained for Athens. In addition, the *RMSE* became stable, with approximately the same values for both thermal masses. Finally, the *RMSE* can be accurately expressed by a power regression, especially for the

heavy thermal mass ( $R^2 = 0.98092$ ).

For Athens, a high level of agreement was observed between the results of the metamodel and the dynamic simulations, with errors below  $0.5 \text{ kWh year}^{-1}$  for the lightweight thermal mass and below  $1.6 \text{ kWh year}^{-1}$  for the heavy thermal mass. When considering the cooling energy needs (Fig. 6), we can deduce that there was practically no difference between the results obtained with the metamodel and dynamic simulation. Furthermore, the *RMSE* for the lightweight thermal mass was almost constant. Although the *RMSE* increased linearly as a function of  $p_{ig,o}$  for the heavy thermal mass ( $R^2 = 0.95338$ ), the slope was  $0.0255 \text{ kWh year}^{-1} \text{ W}^{-1} \text{ m}^2$ , which is less than  $1/1000$  of the energy needs of  $29.306 \text{ kWh year}^{-1} \text{ W}^{-1} \text{ m}^2$ .

The validity of the metamodel was also checked by examining the residuals of Eq. (1) for internal heat gains  $p_{ig,o}$  of 5 and  $40 \text{ W m}^{-2}$ . The residuals versus the energy needs predicted by the metamodel are illustrated in Figs. 8 and 9, for Helsinki and Athens, respectively.

For Helsinki, when  $p_{ig}$  was equal to  $5 \text{ W m}^{-2}$ , the energy needs were equal or close to zero. This was true for some results with the lightweight thermal mass and for most with the heavy thermal mass. For the lightweight thermal mass, a concave curve was obtained for the residuals of the metamodel. This suggests that the extension of the metamodel using third order or exponential terms, changing the experimental design or modifying the lower and upper levels of the parameters (Table 2) might enhance the fit. Moreover, the metamodel was not appropriate for the heavy thermal mass. The same modification could be tested but alternative metamodels might produce more accurate approximations. However, when the internal heat gains were  $40 \text{ W m}^{-2}$ , the residuals seemed to be randomly distributed around zero, indicating that the metamodel was

appropriate.

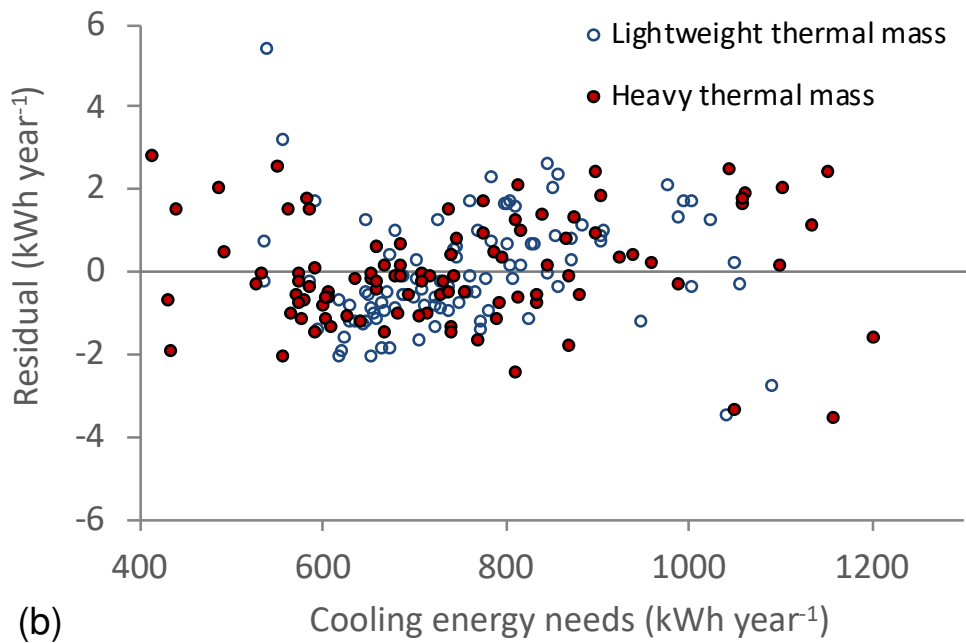
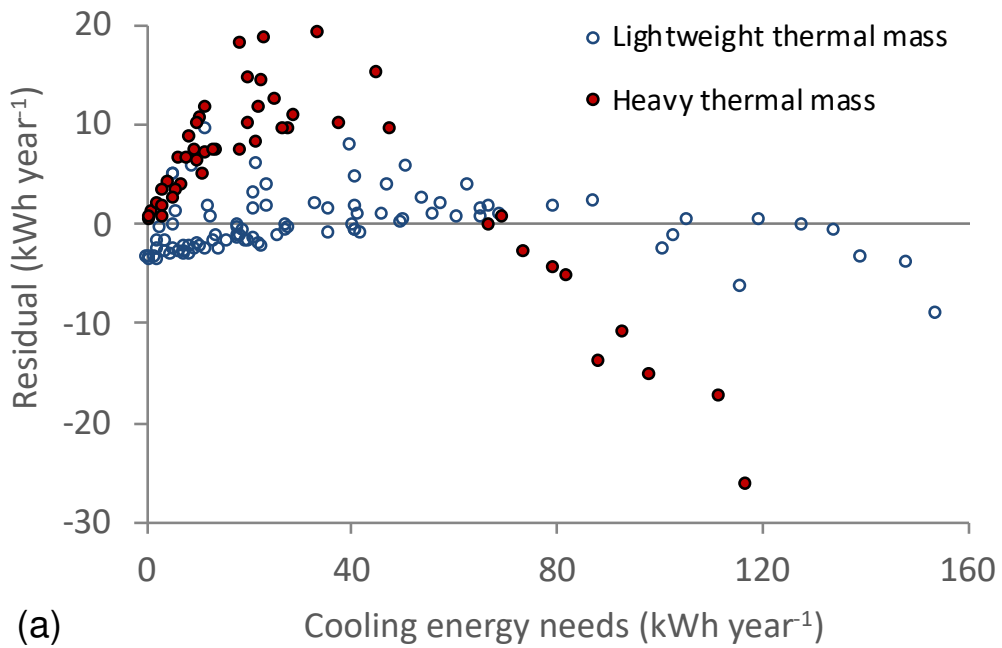

Fig. 8. Residual of the metamodel versus the cooling energy needs for Helsinki with internal heat gains of: (a)  $5 \text{ W m}^{-2}$  and (b)  $40 \text{ W m}^{-2}$ .

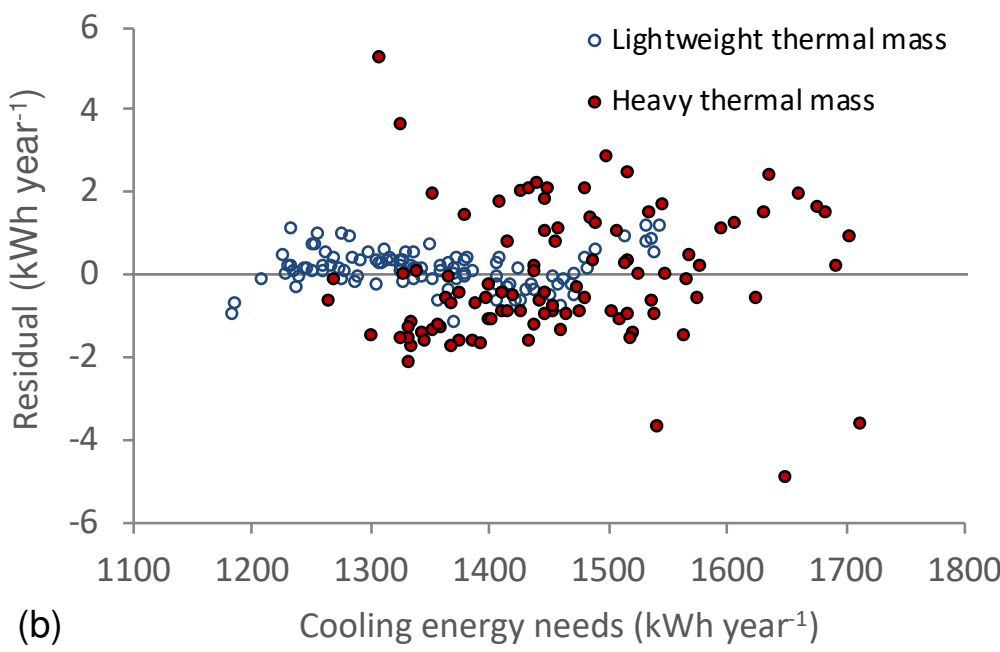
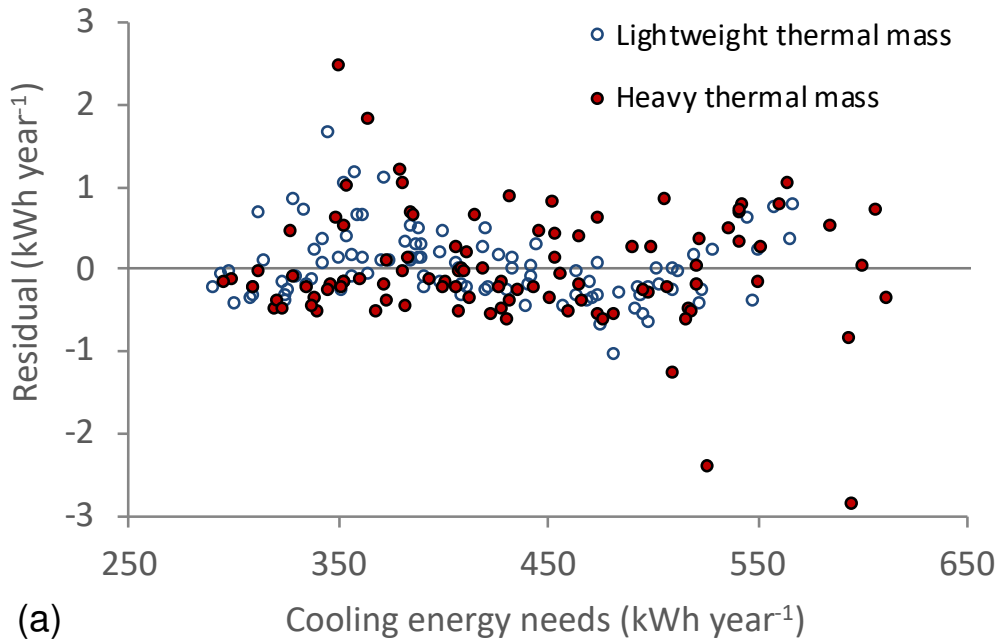

Fig. 9. Residual of the metamodel versus the cooling energy needs for Athens with internal heat gains of: (a)  $5 \text{ W m}^{-2}$  and (b)  $40 \text{ W m}^{-2}$ .

For Athens, the random distribution of the residuals around zero for each  $p_{ig}$  value indicated that the metamodel was appropriate. Some points might be considered as outliers, but a larger number of samples will be needed to verify this. Finally, further analysis of the residuals would be necessary in order to test the metamodel in different

conditions, especially for energy performance close to zero, and to compare it with alternative metamodells.

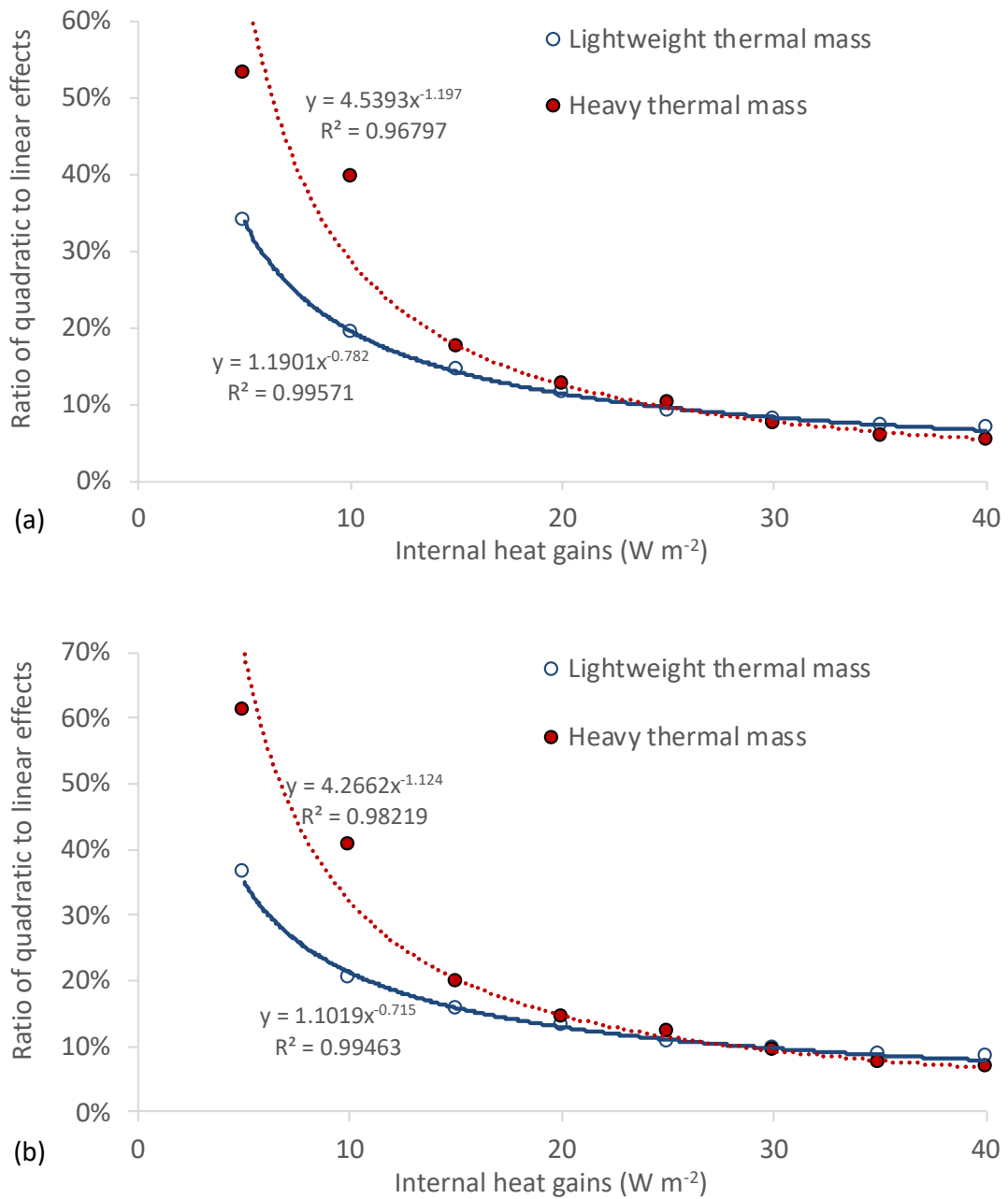

Fig. 10. Ratio of quadratic to linear effects for Helsinki versus internal heat gains: (a) absolute value and (b) root mean square.

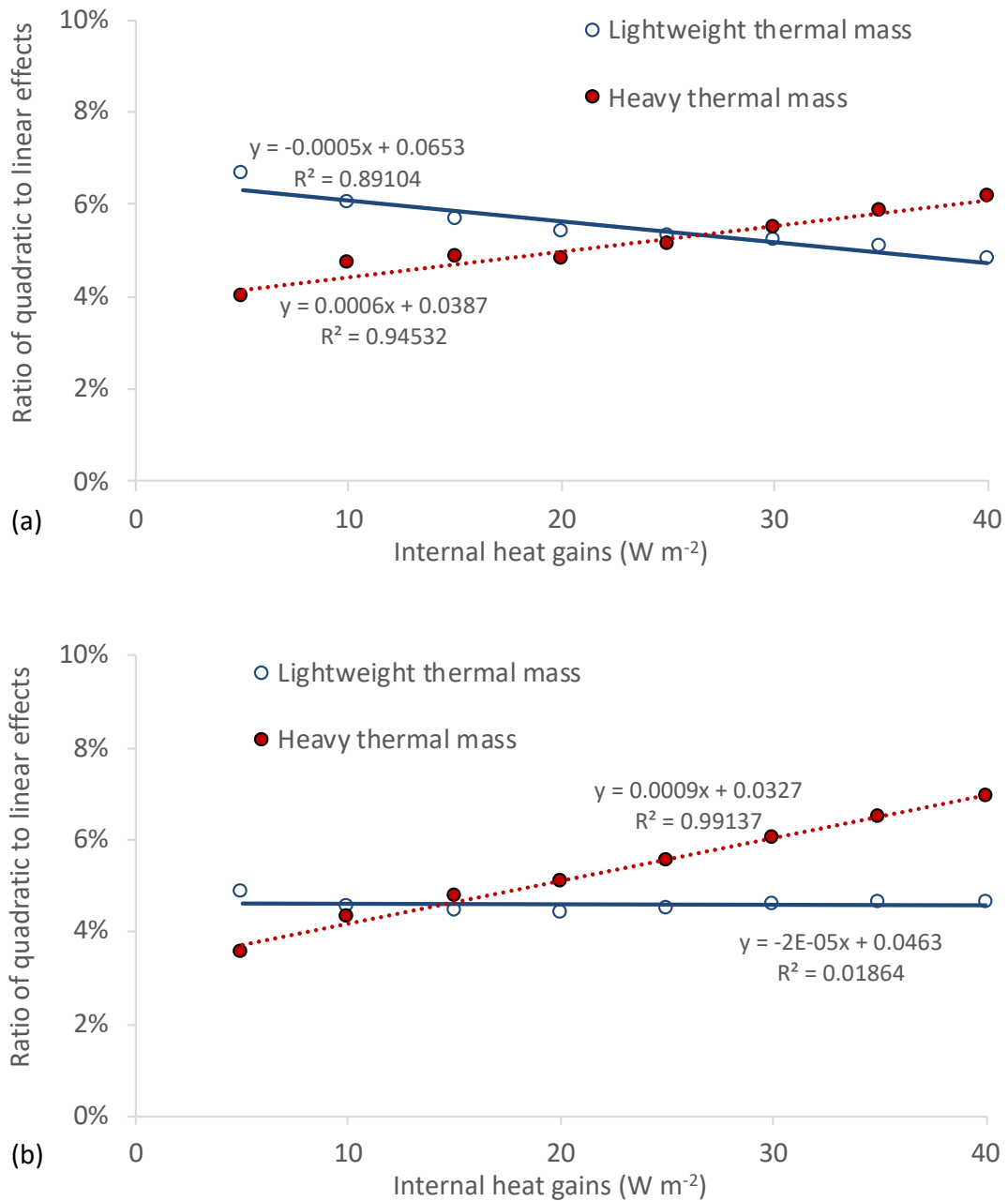

Fig. 11. Ratio of quadratic to linear effects for Athens versus internal heat gains: (a) absolute value and (b) root mean square.

### 3.2.4. Nonlinearity study

The nonlinearity of thermal behavior was studied as a function of internal heat gains  $p_{ig,o}$  using the measures of Eq. (5-8). The variation in the ratios of quadratic to linear effects  $QL_{MA}$  (Eq. (5))  $QL_{RMS}$  (Eq. (7)) versus  $p_{ig,o}$  are illustrated in Figs. 10 and 11 for

Helsinki and Athens, respectively.

For the cold climate of Helsinki, the results showed that  $QL_{MA}$  and  $QL_{RMS}$  were high when  $p_{ig,o}$  was 5 and 10 W m<sup>-2</sup>, i.e. when the cooling energy needs were close to zero. In addition, they were strongly associated with  $p_{ig,o}$  using power laws, with coefficients of determination  $R^2$  higher than 0.96. Both showed similar patterns, but a better fit was again found for the lightweight thermal mass. Furthermore, when the internal gains were low, the quadratic behavior was more pronounced with a heavy thermal mass; above 20 W m<sup>-2</sup> the difference was lower and even the behavior with a lightweight thermal mass was slightly more quadratic above 30 W m<sup>-2</sup>.

For the hot climate of Athens, there was a slight linear variation of  $QL_{MA}$  and  $QL_{RMS}$ , with  $QL_{MA}$  varying from 4.8% to 6.6% for the lightweight thermal mass and from 4.0% to 6.2% for the heavy thermal mass. We deduced that the nonlinearities were almost stable in these conditions.

The ratios of interaction to linear effects  $IL_{MA}$  (Eq. (6))  $IL_{RMS}$  (Eq. (8)) versus  $p_{ig,o}$  are illustrated in Figs. 12 and 13. For Helsinki, these ratios followed similar patterns to  $QL_{MA}$  and  $QL_{RMS}$ . They were also strongly associated with  $p_{ig,o}$ , with coefficients of determination  $R^2$  higher than 0.97. For Athens,  $IL_{MA}$  and  $IL_{RMS}$  were quasi-constant, with higher values for heavy thermal mass.

Finally, the ratios of interaction to linear effects  $IL_{MA}$  and  $IL_{RMS}$  were higher than for quadratic to linear effects  $QL_{MA}$  and  $QL_{RMS}$  whatever the internal heat gains. This was also shown previously in relation to the mean outdoor air temperature of the climates. Thus, the interaction between the building components had a stronger effect than quadratic behavior.



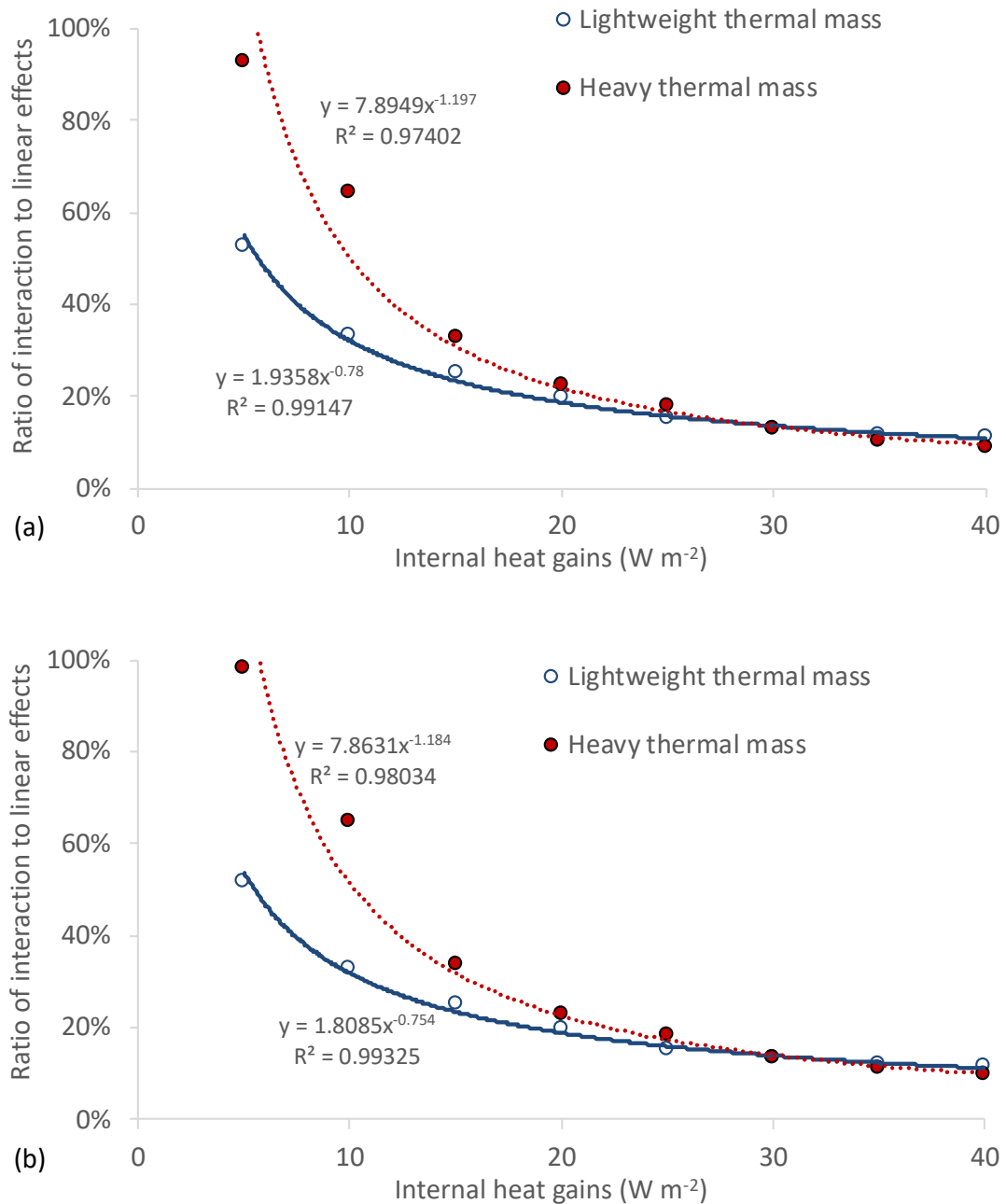

Fig. 12. Ratio of interaction to linear effects for Helsinki versus internal heat gains: (a) absolute value and (b) root mean square.

### 3.2.5. Application to window-wall ratio

The metamodel was fitted for each condition for a fixed geometry with a window-wall ratio of 30%. In this section, we will present a metamodel of physical and geometric design parameters derived from the metamodel of the individual energy needs (Eq. (1)).

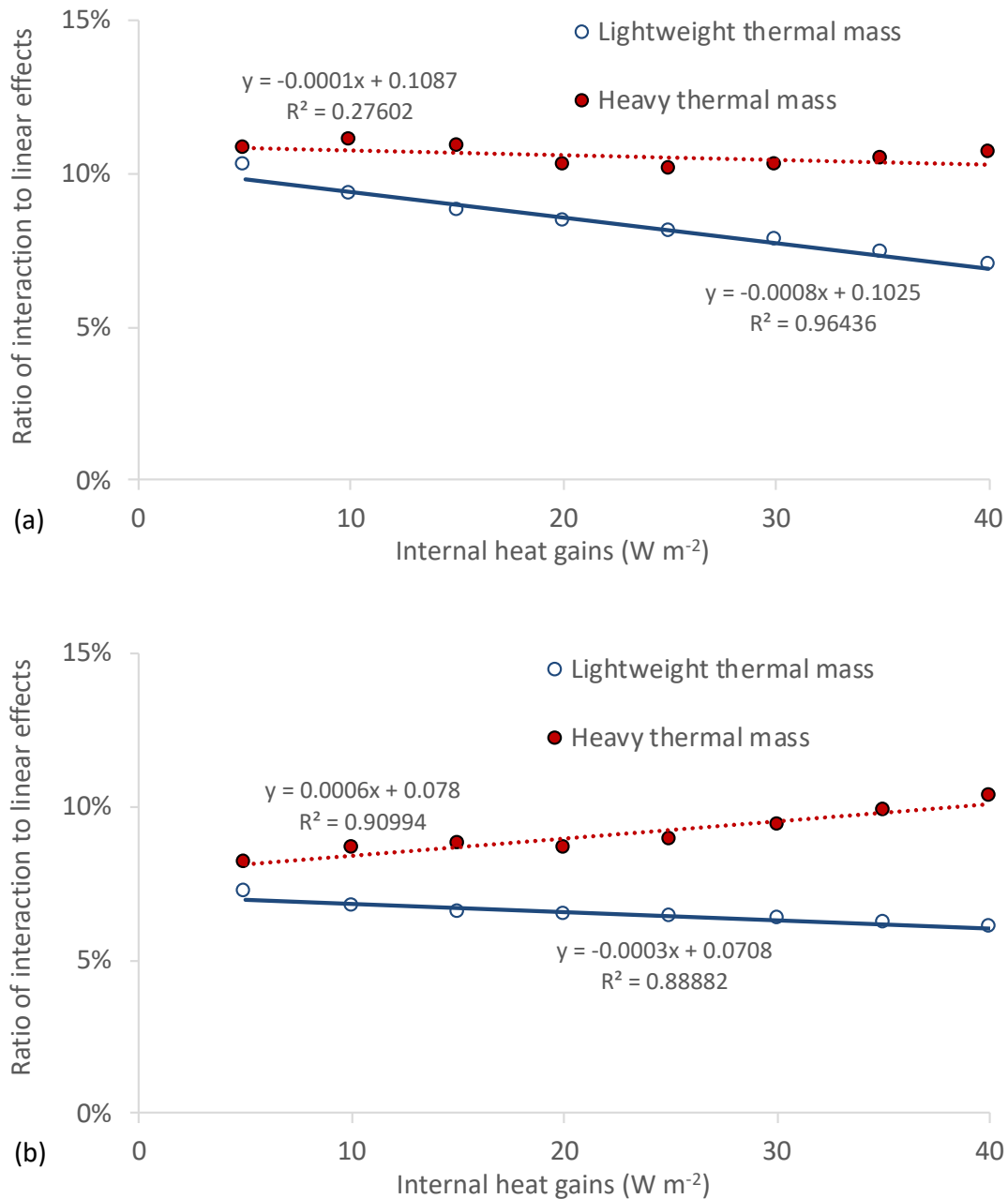

Fig. 13. Ratio of interaction to linear effects for Athens versus internal heat gains: (a) absolute value and (b) root mean square.

The derivation was obtained using the same environmental conditions (e.g. outdoor temperature, solar irradiance, indoor conditions). As result, we obtained a metamodel that gives the energy needs directly as a function of the physical (U-values, infiltration rate and window *SHGC*) and geometric parameters, which is expressed as

$$Q_c = b_0 + \sum_{i=1}^n b_i p_i g_i + \sum_{i=1}^n b_{ii} p_i^2 g_i^2 + \sum_{i=1}^n \sum_{j=i+1}^n b_{ij} p_i p_j g_i g_j \quad (12)$$

where  $p_i$  is a physical parameter,  $g_i$  is a geometric parameter and  $b_0$ ,  $b_i$ ,  $b_{ii}$ , and  $b_{ij}$  are the metamodel coefficients obtained, without additional fitting, from the coefficients  $a_0$ ,  $a_i$ ,  $a_{ii}$ , and  $a_{ij}$  using Eqs. (1)-(4).

Table 5. Coefficients of the metamodel for Helsinki and Athens with internal heat gains of 20 W m<sup>-2</sup>.

Location	Helsinki		Athens	
Thermal mass	Lightweight	Heavy	Lightweight	Heavy
$a_0$	397.17	456.50	616.42	724.55
$a_1$	-27.98	-40.72	-7.75	-12.58
$a_2$	-32.91	-45.40	-11.10	-17.33
$a_3$	-8.68	-12.99	-2.19	-4.14
$a_4$	139.78	178.55	138.57	164.85
$a_{11}$	0.47	0.90	0.12	0.17
$a_{22}$	0.72	0.98	0.20	0.27
$a_{33}$	0.06	0.09	0.02	0.03
$a_{44}$	6.22	7.71	2.43	0.22
$a_{12}$	1.33	1.81	0.31	0.51
$a_{13}$	0.33	0.52	0.08	0.14
$a_{14}$	-4.03	-5.59	-1.25	-1.84
$a_{23}$	0.36	0.56	0.11	0.17
$a_{24}$	-3.91	-5.77	-1.23	-1.62
$a_{34}$	-1.02	-1.66	-0.31	-0.44

As an example,  $b_1$  was obtained from the coefficient  $a_1$  using Eq. (2) according to

$$b_1 = a_1 \frac{Q_{tr,ow}}{\sum(\theta_{is} - \theta_{oe})\Delta t} \quad (13)$$

The values of the coefficients  $b_0$ ,  $b_i$ ,  $b_{ii}$ , and  $b_{ij}$  of Eq. (11) for both climates and both thermal masses with heat gains of 20 W m<sup>-2</sup> are given in Table 5. The metamodel variables are expressed here with their specific units. The signs of the effects are similar to those of the coded variables, which allows to identify the components that contribute to a decrease in building energy needs.

Once the metamodel coefficients were calculated, the cooling energy needs  $Q_c$  could be calculated directly from the physical and geometric parameters. For instance, the metamodel for Athens and the heavy thermal mass is given by

$$\begin{aligned}
Q_c = & 724.55 - 12.58A_{ow} - 17.33U_wA_w - 4.14q_{v,inf,r} \\
& + 164.85SHGC_{w,r}A_w + 0.17U_{ow}^2A_{ow}^2 + 0.27U_w^2A_w^2 \\
& + 0.03q_{v,inf,r}^2 + 0.22SHGC_{w,r}^2A_w^2 + 0.51U_{ow}U_wA_{ow}A_w \\
& + 0.14U_{ow}q_{v,inf,r}A_{ow} - 1.84U_{ow}SHGC_{w,r}A_{ow}A_w \\
& + 0.17U_wq_{v,inf,r}A_w - 1.62U_wSHGC_{w,r}A_w^2 \\
& - 0.44q_{v,inf,r}SHGC_{w,r}A_w
\end{aligned} \tag{14}$$

Using this equation, the cooling energy needs can be obtained almost instantaneously, whereas a TRNSYS simulation of the office studied took several seconds to run. Therefore, the metamodel is particularly useful for assessing the performance of a large number of design configurations and for formulating the optimization problems of a building. Moreover, it is convenient for early design stages when many design details are still not available. Furthermore, it offers the benefit of studying the energy needs at the district level, where the use of dynamic simulation quickly becomes impractical.

The results of the metamodels were compared with those of the dynamic simulation of TRNSYS for window-wall ratios ranging from 15% to 60%. For each ratio, 100 additional dynamic simulations were performed with a random combination of the physical parameters.

The mean values of the cooling energy needs of the 100 dynamic simulations versus

window-wall ratio are illustrated in Fig. 14 for both climates and thermal masses. In each case, the cooling energy needs increased with the window-wall ratio due to higher solar gain. In addition, the variation was almost perfectly linear.

The cooling energy needs were again lower for the heavy thermal mass in Helsinki and the lightweight mass in Athens. However, the difference between the thermal masses increased in Helsinki and decreased in Athens with the window-wall ratio. In other words, a heavy thermal mass was more convenient when the solar gain was high.

The *RMSE* of the metamodel versus window-wall ratio is presented in Fig. 15. As expected, the accuracy of the metamodel decreased the farther the window-wall ratio was from the fitted value of 30%. The errors were hence due to the extrapolation of the metamodel when the window-wall ratio varied.

However, the *RMSE* were still low when the window-wall ratio was between 15% and 45% but increased rapidly when this ratio was above 45%. Nevertheless, the levels of accuracy of the metamodel could be acceptable when comparing the *RMSE* to the energy needs (Fig. 14), especially for Athens. Moreover, the *RMSE* was again higher for the heavy thermal mass, with a larger difference for higher window-wall ratios for Helsinki and a lower difference in Athens. A better accuracy would be obtained by using the lower and upper levels of the geometric parameters when fitting the metamodels together with the physical parameters in Table 2.

Finally, the *RMSE* was almost perfectly expressed by a quadratic polynomial in each case. It would be useful to incorporate this assumption into a correction term for the metamodel errors in the polynomials of Eqs. (11) and (13).

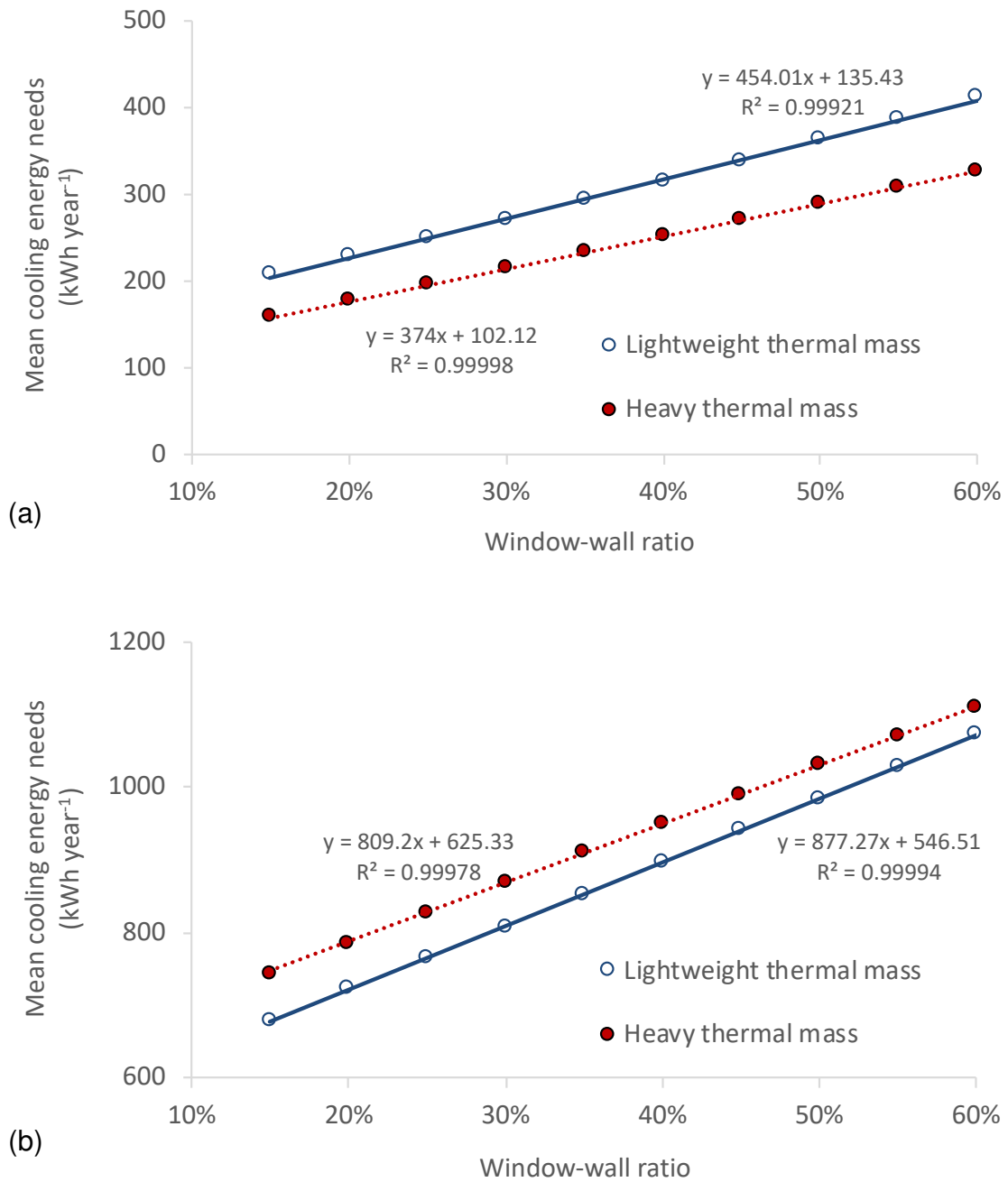

Fig. 14. Mean cooling energy needs as given by dynamic simulation versus window-wall ratio: (a) Helsinki and (b) Athens.

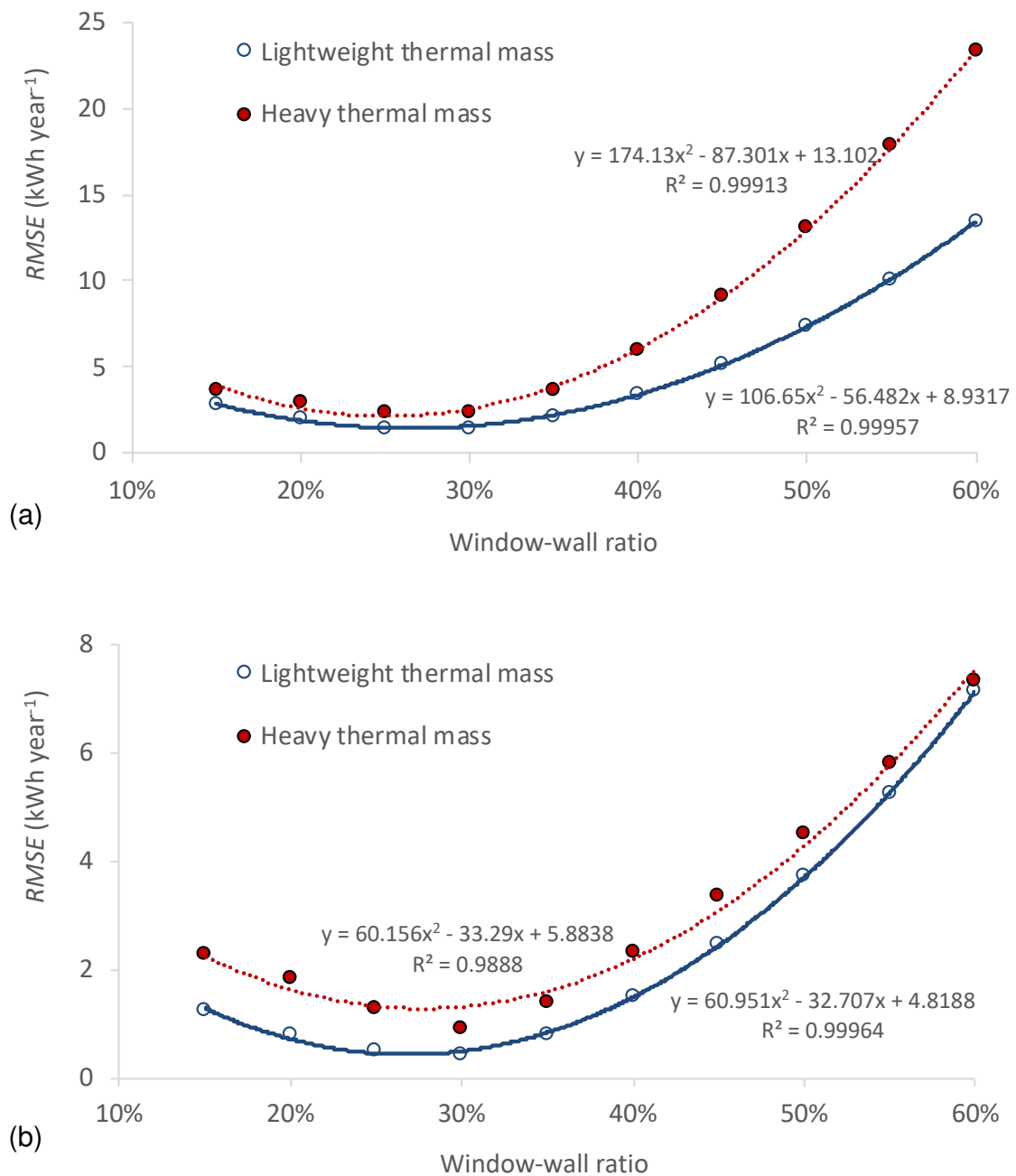

Fig. 15. *RMSE* of the metamodel for cooling energy needs versus window-wall ratio: (a) Helsinki and (b) Athens.

### Conclusions

A metamodeling method to study nonlinearities in the thermal behavior of a building was presented. The presented metamodel can be used for rapidly assessing building

energy performance and for providing insight into building thermal behavior. Four nonlinearity measures were introduced using the metamodel coefficients allowing to assess the relative importance of the quadratic and interaction effects in the metamodel.

The method was applied to the analysis of the nonlinearities in the thermal behavior of an office in relation to the mean outdoor air temperature of fifteen typical European climates. In addition, the analysis was performed with different levels of internal heat gains for the coldest and hottest climates.

It was observed that metamodel errors generally decreased with mean outdoor air temperature and internal heat gains, i.e. when the cooling energy needs were high. When the climate was hot and internal heat gains were high, there was practically no difference between the results of the metamodel and dynamic simulation. In addition, higher accuracies were obtained for the lightweight thermal mass, which may be related to the quasi-steady state assumption on which the metamodel is based. The metamodel errors could be accurately associated with mean outdoor air temperature and internal heat gains with power laws when the energy needs were low. However, this association was linear and quasi-constant in hot climates and with high internal heat gains.

The nonlinearity of thermal behavior was accentuated when the climate was cold, with low internal heat gains, i.e. when energy needs were low and the metamodel errors high. The nonlinearity measures were accurately associated with the mean outdoor air temperature of the climates in accordance with decreasing power laws. Similar patterns were observed with internal heat gains for cold climates. However, for hot climates, the nonlinearities were quasi-stable, with a linear variation with respect to internal heat gains. It should be noticed that the interactions between the building components was found to be more influential on cooling energy needs than quadratic behavior.



It was shown that the fitted metamodels for cooling were convex functions of heat transfer. Moreover, the interaction effects highlight the fact that a heat loss reduces cooling energy needs more significantly when the other heat losses are low and the solar heat gain is high. Furthermore, a metamodel was derived to calculate the energy needs from the physical and geometric parameters of the building, which is particularly useful in early design stages when there is little available information on the building.

Following the results of this study, we propose to classify building thermal behavior into three regimes: highly nonlinear close to zero energy needs; intermediate with decreasing nonlinearities that can be expressed by power functions; and, finally, a quasi-linear regime with low and almost-steady nonlinearities where linear assumption methods may be accepted.

When the energy needs were close to zero, the thermal behavior was highly nonlinear with a relatively low metamodeling accuracy. The analysis of the nonlinearities in such conditions would require further investigation. For instance, the proposed metamodel can be fitted using various experimental designs and can be extended using third order or exponential terms. Moreover, alternative metamodels (e.g. artificial neural networks, radial basis functions, support vector machines, kriging) might produce more accurate approximations. However, some metamodels are computationally intensive and their coefficients would provide less insight than our metamodel that is based on a polynomial assumption.

The presented method could be used for the development of simplified models for assessing building energy performance, in particular in future building standards. Moreover, it could be useful for guiding the choice of a sensitivity analysis method and for improving optimization efficiency. However, further work would be necessary to

understand the nonlinearities in thermal behavior using metamodeling. In particular, the study of the influence of climate factors and energy systems is an interesting subject for research. In addition, it would be useful to identify the conditions in which nonlinear terms would be necessary to ensure the accuracy of simplified methods for use in future building standards. It would be also interesting to investigate the effects of nonlinearities in the design of buildings and their HVAC systems.

We expect that new flexible metamodels will be developed in the near future to study the building energy and environmental performance. Subsequently, it would be possible to represent buildings and energy systems with several metamodels in interactions. This would lead to improve their design and to provide a better understanding of their behavior.

## References

- [1] Kleijnen JPC. Statistical tools for simulation practitioners. New York: Marcel Dekker; 1987.
- [2] Simpson TW, Poplinski JD, Koch PN, Allen JK. Metamodels for computer-based engineering design: survey and recommendations. *Engineering with computers*. 2001;17:129-50.
- [3] Jin R, Chen W, Simpson TW. Comparative studies of metamodelling techniques under multiple modelling criteria. *Structural and multidisciplinary optimization*. 2001;23:1-13.
- [4] Li Y-F, Ng SH, Xie M, Goh TN. A systematic comparison of metamodeling techniques for simulation optimization in decision support systems. *Applied Soft Computing*. 2010;10:1257-73.
- [5] Montgomery DC. Design and analysis of experiments. Hoboken, NJ: John Wiley & Sons; 2017.
- [6] Gratia E, De Herde A. A simple design tool for the thermal study of an office building. *Energy and Buildings*. 2002;34:279-89.
- [7] Jin J-T, Jeong J-W. Thermal characteristic prediction models for a free-form building in various climate zones. *Energy*. 2013;50:468-76.
- [8] Xu J, Kim J-H, Hong H, Koo J. A systematic approach for energy efficient building design factors optimization. *Energy and Buildings*. 2015;89:87-96.
- [9] Pino-Mejías R, Pérez-Fargallo A, Rubio-Bellido C, Pulido-Arcas J. Comparison of linear regression and artificial neural networks models to predict heating and cooling energy demand, energy consumption and CO<sub>2</sub> emissions. *Energy*. 2017;118:24-36.
- [10] Chung W, Hui YV, Lam YM. Benchmarking the energy efficiency of commercial buildings. *Applied Energy*. 2006;83:1-14.
- [11] Shiming D, Burnett J. Energy use and management in hotels in Hong Kong. *International Journal of Hospitality Management*. 2002;21:371-80.
- [12] Aranda A, Ferreira G, Mainar-Toledo MD, Scarpellini S, Llera Sastresa E. Multiple regression models to predict the annual energy consumption in the Spanish banking sector. *Energy and Buildings*. 2012;49:380-7.
- [13] Melo AP, Fossati M, Versage RS, Sorgato MJ, Scalco VA, Lamberts R. Development and analysis of a metamodel to represent the thermal behavior of

- naturally ventilated and artificially air-conditioned residential buildings. *Energy and Buildings*. 2016;112:209-21.
- [14] Lam JC, Wan KKW, Lam TNT, Wong SL. An analysis of future building energy use in subtropical Hong Kong. *Energy*. 2010;35:1482-90.
- [15] Wan KKW, Li DHW, Lam JC. Assessment of climate change impact on building energy use and mitigation measures in subtropical climates. *Energy*. 2011;36:1404-14.
- [16] Braun MR, Altan H, Beck SBM. Using regression analysis to predict the future energy consumption of a supermarket in the UK. *Applied Energy*. 2014;130:305-13.
- [17] Mastrucci A, Baume O, Stazi F, Leopold U. Estimating energy savings for the residential building stock of an entire city: A GIS-based statistical downscaling approach applied to Rotterdam. *Energy and Buildings*. 2014;75:358-67.
- [18] Ashtiani A, Mirzaei PA, Haghightat F. Indoor thermal condition in urban heat island: Comparison of the artificial neural network and regression methods prediction. *Energy and buildings*. 2014;76:597-604.
- [19] Özbalta TG, Sezer A, Yildiz Y. Models for prediction of daily mean indoor temperature and relative humidity: Education building in Izmir, Turkey. *Indoor and Built Environment*. 2012;21:772-81.
- [20] Patidar S, Jenkins DP, Gibson GJ, Banfill PFG. Statistical techniques to emulate dynamic building simulations for overheating analyses in future probabilistic climates. *Journal of Building Performance Simulation*. 2011;4:271-84.
- [21] Van Gelder L, Janssen H, Roels S. Metamodelling in robust low-energy dwelling design. 2nd Central European Symposium on Building Physics. Vienna, Austria 2013. p. 93-9.
- [22] Hygh JS, DeCarolis JF, Hill DB, Ranjithan SR. Multivariate regression as an energy assessment tool in early building design. *Building and Environment*. 2012;57:165-75.
- [23] Karatasou S, Santamouris M, Geros V. Modeling and predicting building's energy use with artificial neural networks: Methods and results. *Energy and buildings*. 2006;38:949-58.
- [24] Neto AH, Fiorelli FvAS. Comparison between detailed model simulation and artificial neural network for forecasting building energy consumption. *Energy and buildings*. 2008;40:2169-76.

- [25] Deb C, Eang LS, Yang J, Santamouris M. Forecasting diurnal cooling energy load for institutional buildings using Artificial Neural Networks. *Energy and Buildings*. 2016;121:284-97.
- [26] Macas M, Moretti F, Fonti A, Giantomassi A, Comodi G, Annunziato M, et al. The role of data sample size and dimensionality in neural network based forecasting of building heating related variables. *Energy and Buildings*. 2016;111:299-310.
- [27] Ascione F, Bianco N, De Stasio C, Mauro GM, Vanoli GP. Artificial neural networks to predict energy performance and retrofit scenarios for any member of a building category: A novel approach. *Energy*. 2017;118:999-1017.
- [28] Symonds P, Taylor J, Chalabi Z, Davies M. Performance of Neural Networks vs. Radial Basis Functions When Forming a Metamodel for Residential Buildings. *World Academy of Science, Engineering and Technology, International Journal Of Civil, Environmental, Structural, Construction And Architectural Engineering*. 2015;9:1446-50.
- [29] Dong B, Cao C, Lee SE. Applying support vector machines to predict building energy consumption in tropical region. *Energy and Buildings*. 2005;37:545-53.
- [30] Li Q, Meng Q, Cai J, Yoshino H, Mochida A. Predicting hourly cooling load in the building: a comparison of support vector machine and different artificial neural networks. *Energy Conversion and Management*. 2009;50:90-6.
- [31] Heo Y, Zavala VM. Gaussian process modeling for measurement and verification of building energy savings. *Energy and Buildings*. 2012;53:7-18.
- [32] Chen X, Yang H, Sun K. Developing a meta-model for sensitivity analyses and prediction of building performance for passively designed high-rise residential buildings. *Applied energy*. 2017;194:422-39.
- [33] Van Gelder L, Das P, Janssen H, Roels S. Comparative study of metamodelling techniques in building energy simulation: Guidelines for practitioners. *Simulation Modelling Practice and Theory*. 2014;49:245-57.
- [34] Melo AP, Versage RS, Sawaya G, Lamberts R. A novel surrogate model to support building energy labelling system: A new approach to assess cooling energy demand in commercial buildings. *Energy and Buildings*. 2016;131:233-47.
- [35] Tso GKF, Yau KKW. Predicting electricity energy consumption: A comparison of regression analysis, decision tree and neural networks. *Energy*. 2007;32:1761-8.
- [36] del Coz Diaz JJ, Garcia-Nieto PJ, Alvarez-Rabanal FP, Alonso-Martínez M, Dominguez-Hernandez J, Perez-Bella JM. The use of response surface

- methodology to improve the thermal transmittance of lightweight concrete hollow bricks by FEM. *Construction and Building Materials*. 2014;52:331-44.
- [37] Capozzoli A, Gorrino A, Corrado V. A building thermal bridges sensitivity analysis. *Applied Energy*. 2013;107:229-43.
- [38] Kuznik F, Arzamendia Lopez JP, Baillis D, Johannes K. Phase change material wall optimization for heating using metamodeling. *Energy and Buildings*. 2015;106:216-24.
- [39] Asadi S, Hassan M, Beheshti A. Development and validation of a simple estimating tool to predict heating and cooling energy demand for attics of residential buildings. *Energy and Buildings*. 2012;54:12-21.
- [40] Banihashemi S, Golizadeh H, Reza Hosseini M, Shakouri M. Climatic, parametric and non-parametric analysis of energy performance of double-glazed windows in different climates. *International Journal of Sustainable Built Environment*. 2015;4:307-22.
- [41] Sofotasiou P, Calautit JK, Hughes BR, O'Connor D. Towards an integrated computational method to determine internal spaces for optimum environmental conditions. *Computers & Fluids*. 2016;127:146-60.
- [42] Hang Y, Qu M, Ukkusuri S. Optimizing the design of a solar cooling system using central composite design techniques. *Energy and Buildings*. 2011;43:988-94.
- [43] Niu F, Yu Y, Yu D, Li H. Heat and mass transfer performance analysis and cooling capacity prediction of earth to air heat exchanger. *Applied Energy*. 2015;137:211-21.
- [44] Castorani V, Landi D, Germani M. Determination of the optimal configuration of energy recovery ventilator through virtual prototyping and DoE techniques. *Procedia CIRP*. 2016;50:52-7.
- [45] Aste N, Del Pero C, Leonforte F, Manfren M. A simplified model for the estimation of energy production of PV systems. *Energy*. 2013;59:503-12.
- [46] Schmelas M, Feldmann T, Bollin E. Adaptive predictive control of thermo-active building systems (TABS) based on a multiple regression algorithm. *Energy and Buildings*. 2015;103:14-28.
- [47] Gong X, Akashi Y, Sumiyoshi D. Optimization of passive design measures for residential buildings in different Chinese areas. *Building and Environment*. 2012;58:46-57.

- [48] Rasouli M, Ge G, Simonson CJ, Besant RW. Uncertainties in energy and economic performance of HVAC systems and energy recovery ventilators due to uncertainties in building and HVAC parameters. *Applied Thermal Engineering*. 2013;50:732-42.
- [49] Carlo J, Lamberts R. Development of envelope efficiency labels for commercial buildings: Effect of different variables on electricity consumption. *Energy and Buildings*. 2008;40:2002-8.
- [50] Sanchez DG, Lacarrière B, Musy M, Bourges B. Application of sensitivity analysis in building energy simulations: Combining first-and second-order elementary effects methods. *Energy and Buildings*. 2014;68:741-50.
- [51] Maderspacher J, Geyer P, Auer T, Lang W. Comparison of different meta model approaches with a detailed buiding model for long-term simulations. *Building Simulation Conference*. Hyderabad, India 2015. p. 106-13.
- [52] Lam JC, Hui SCM, Chan ALS. Regression analysis of high-rise fully air-conditioned of fice buildings. *Energy and Buildings*. 1997;26:189-98.
- [53] Jaffal I, Inard C, Ghiaus C. Fast method to predict building heating demand based on the design of experiments. *Energy and Buildings*. 2009;41:669-77.
- [54] Jaffal I, Inard C. A metamodel for building energy performance. *Energy and Buildings*. 2017;151:501-10.
- [55] EnergyPlus Version 8.9.0 Documentation, US Department of Energy. 2018.
- [56] Klein SA, et al. TRNSYS 16 - A TRaNsient SYstem Simulation program, User manual. Madison, WI: Solar Energy Laboratory, University of Wisconsin-Madison; 2004.
- [57] Stephenson DG, Mitalas GP. Calculation of heat conduction transfer functions for multi-layers slabs. *ASHRAE Transactions*. 1971;77:117-26.
- [58] Box GEP, Behnken DW. Some new three level designs for the study of quantitative variables. *Technometrics*. 1960;2:455-75.